



Silencer Catalog



Content - Silencers

General information on noise 3
 General information on sound attenuation..... 4
 Silencer specification 7

Silencers for spiral systems

Straight silencers



SLGU 9
 SLGU 04 10
 SLGU 06 15

Baffle silencers



SLBGU 04..... 20

Elbow silencers



BSLGU..... 30

Silencers for rectangular systems

Rectangular silencers



SLRS..... 34

Baffles

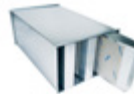

SLRA..... 35

General information on noise

Noise is generally accepted as unwanted sound. Noise in a ventilation system is a very complex and diverse phenomenon. There are often many noise sources occurring at the same time, which affects our perception of noise. It can be difficult to separate these noise sources from each other; however, it is very important to be able to separate them so that the appropriate sound attenuator can be installed.

Noise sources

In principle, the noise sources in a ventilation system can be roughly divided into the following main areas:

1. fan noise
 1. fan noise
 2. duct noise
 3. noise from dampers, leaks, etc.
 4. building noise

Noise from the fan can be divided into air flow noise and operating noise. Air flow noise is a function of the velocity and pressure. Operating noise comes from the fan motor, belt drives, bearings, etc. The air flow noise is usually the worst problem. The critical frequency is often the fan impeller frequency, f_s .

$$f_s = n/60 \cdot s \text{ (Hz)}$$

n = number of revolutions (rpm)
 s = number of blades
2. Duct noise

Duct noise is generated primarily when the air flow passes sharp edges, dampers, turning vanes in rectangular elbows and poorly installed saddle taps. Any obstruction to the air flow will cause turbulence and noise. Secondary duct noise may also originate from the transmission of noise through the duct from room to room.
3. Damper noise, valve noise, etc.

Noise may also be caused near valves, dampers as the air flow passes through relatively small holes. Noise may also be caused by poor joints or leaks.
4. Building noise

Building noise is the noise which is transmitted through parts of a building: walls, floors, ceilings and other components.

Noise or sound attenuation

It is desirable and often required that noise be attenuated or removed. Silencers are specially designed for attenuating noise originating from the sources specified in items 1 and 2 above. Before investing in sound attenuating products, it is very important to determine the origin of the noise.

What is sound?

Small changes in the normal atmospheric pressure which accompany a sound wave is called the sound pressure. When measuring the sound pressure, a total value for the strength of the sound can be obtained. As an example, the weakest sound the human ear can detect has a sound pressure of $20 \cdot 10^{-6}$ Pa at 1000 Hz. This is defined as the hearing threshold. A sound pressure around 100 Pa would be strong enough that it hurts the human ear. A sound pressure scale using measurements in Pa would become extremely long and cumbersome. For practical reasons the decibel system has been introduced.

Sound pressure level, L_p

The sound pressure level which is measured in dB is an expression of the perception of noise.

$$L_p = 20 \cdot \log\left(\frac{p}{p_0}\right) \quad (\text{dB}) \quad (4.1)$$

Where:

p = the sound pressure in question (Pa)
 p_0 = reference pressure = $20 \cdot 10^{-6}$ (Pa)

Sound power level, L_w

The sound power level which is measured in dB is an expression of the sound power which the system gives off.

$$L_w = 10 \cdot \log\left(\frac{p}{p_0}\right) \quad (\text{dB}) \quad (4.2)$$

Where:

p = sound power in question, W
 p_0 = reference power 10^{-12} , W

Calculation of sound power level, L_p

$$L_p = L_w + 10 \cdot \log\left(\frac{Q}{4p^2} + \frac{4}{R}\right) \quad (\text{dB}) \quad (4.3)$$

Where:

L_w = the sound power level of the sound source, dB
 Q = direction factor
 l = distance between sound source and measuring point, ft
 $R = \frac{S \cdot a}{(a-1)}$ = room constant (ft²)

S = total absorption surface of the room (ft²)
 a = the room's mean absorption coefficient

Octave bands

As it is rarely possible to attenuate low frequencies and high frequencies with the same device, it is necessary to divide the noise into octave bands. This facilitates analysis of the area where the noise is prevalent. The octave bands used in this division are often designated as a given band's mean frequency, f_m . In ventilation systems the bands used are usually those between 1 and 8.

Octave band	1	2	3	4	5	6	7	8
f_m Hz	63	125	250	500	1000	2000	4000	8000

General information on sound attenuation

Sound attenuation is usually required in order to comply with project specifications or to fulfill a wish for a better environment. See Table 5.1. These acceptable noise levels are the result of all sound and noise sources (ventilation, electrical fittings, water pipes, fans in computer equipment, etc.).

Calculation of sound in ventilation systems

A precondition for sizing sound attenuators is to obtain an accurate sound calculation of the system. The sound calculation is based on the sound power level, which is then converted to the sound pressure level. (See Formula 4.3, page 4). In general, the sound power level of the fan must be known. The following must also be available before the sound attenuation calculation can be made:

- Octave band analysis (frequency analysis)
- Definition of desired end result

The A-weighted sound level

It has been found that humans do not perceive two sound pressures of the same magnitude but with different frequencies identically. However, it is possible to make the individual frequencies comparable through appropriate correction (A-filter) of the linear sound pressure level. The value achieved is called the A-weighted sound pressure level, L_{pA} , which is the sum of the corrected sound pressure levels in the individual octave bands. Instruments are available in which the A-filter can be inserted when measuring the individual octave bands. The measurement results are designated: Whole octave A-weighted values, measured in dB.

Specification of requirements

There are 2 methods for specifying the noise requirement:

1. by means of NC
2. by means of L_{pA}

Recommended maximum values for sound pressure levels

Below is a table which indicates the recommended maximum values for sound pressure levels in N-value and L_{pA} . There is no fixed ratio between the various sound specifications, but as long as the noise in question is ventilation noise without pure tones, the following rule of thumb applies: $L_{pA} = NC + 5$

Building type	Room type	NC	L_{pA}
Dwellings	Kitchens	30	35
	Living rooms	25	30
Child-care	Kindergardens	30	35
Institutions	Day nurseries	30	35
Meeting facilities	Lecture halls	25	30
	Libraries	30	35
	Cinemas	30	35
	Concert halls	20	25
	Courtrooms	25	30
Shops	Theaters	25	30
	Retail	35	40
	Department stores	35-45	40-50
Hospitals	Supermarkets	35-45	40-50
	Corridors	30	35
	Operating rooms	25	30
Hotels	Patient rooms	20	25
	Lobbies	35	40
Churches	Function rooms	30	35
	All rooms	25	30
Offices	Conference rooms	30	35
	Large offices	30	35
	Computer rooms, large	40	45
Restaurants	Computer rooms, small	40	45
	Cafeterias	40	45
	Dining rooms	40	45
Schools	Lecture halls	25	30
	Corridors	30	35
	Gymnasiums	30	35
	Staff rooms	30	35
Sports	Gymnasiums	35	40
	Swimming pools	35	40



General information on sound attenuation

The L_{pA} value can be determined as follows:

1. two random A-weighted octave values (usually the two highest) are added logarithmically by means of the curve.
2. the result is added logarithmically to a random third A-weighted octave value.
3. the addition continues and the L_{pA} -value is obtained when the addition includes all A-weighted octave values.

Example: 53 dB + 53 dB + 54 dB:
 53 dB + 53 dB = 53 dB + 3 = 56 dB
 56 dB + 54 dB = 56 dB + 2 = 58 dB

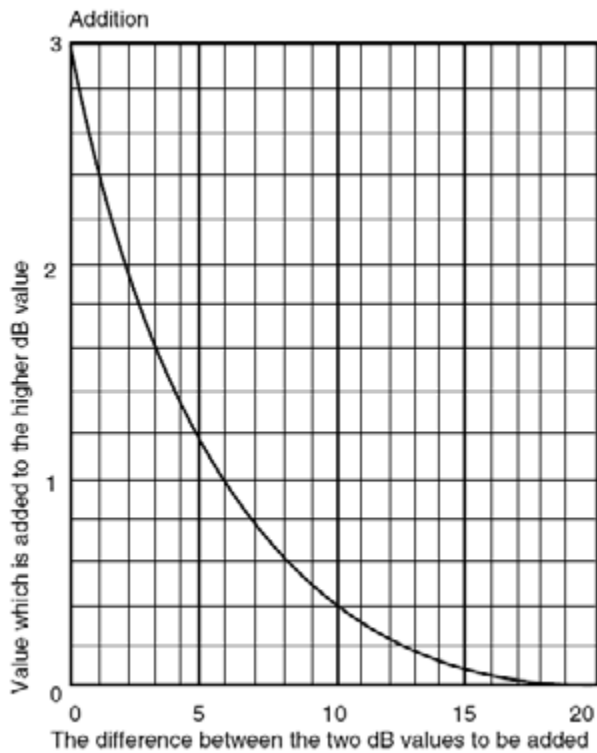

When determining the N-value, the sound levels in question are plotted and the points connected.

NC is determined as the N-curve which touches the spectrogram for the noise entered.

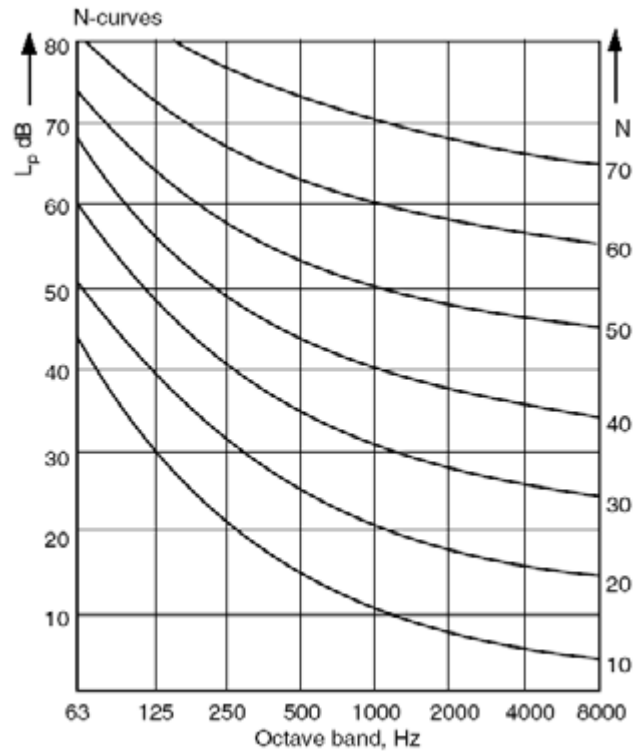

Technical description

Design

The straight silencers in the Linx Industries Silencer range are designed with a spiral seam outer shell and an inner perforated shell. The space between is filled with inorganic glass fiber sound absorption material. There is a fiber retention system between the perforated inner shell and the glass fiber material in order to prevent the erosion of fiberglass into the airstream.

Connection

All silencers are supplied with Lindab Safe® end treatment as standard.

Size Range

All straight silencers are available from 3" to 50" diameter and in standard lengths of 12", 24", 36", 48", 60", 72", 84" and 96", depending on the connection diameter. Please contact the manufacturer for larger diameters.

Elbow silencers are available from 4" to 12" diameter in 2" thickness and from 4" to 24" diameter in 4" thickness.

Technical data

For information on dimensions, weight, insertion loss, self noise and pressure drop refer to the appropriate section for each individual silencer type.

Dimensional sketch for SLGU

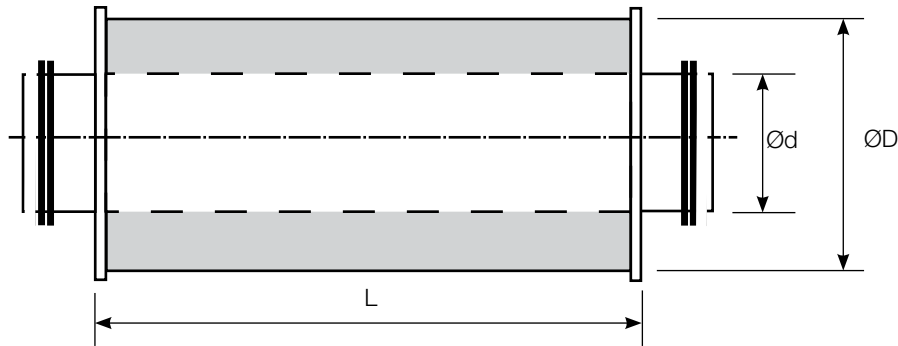

Dimensional sketch for SLBGU

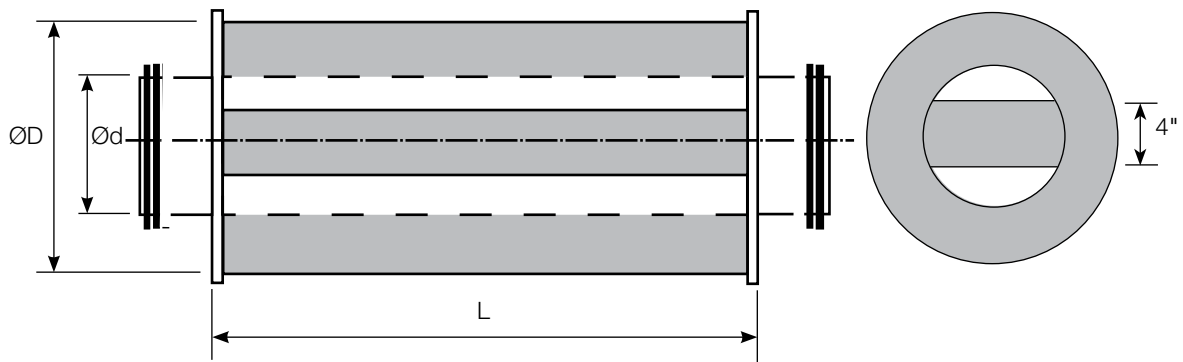

Specification

General

1. All round silencers shown on plans or scheduled shall be manufactured by Linx Industries, Inc. (800) 797-7476 or approved equal. All silencers shall meet manufacturer's published performance data tested according to ASTM E477.
2. The contractor may, at his option, convert any or all double wall or sound lined duct work to silencers provided that the intended sound attenuation is matched or exceeded, the project space limitations are properly addressed and that the overall system design static pressure is not exceeded.

Materials

1. Unless otherwise noted, all silencers shall be a minimum of G-60 galvanized steel in accordance with ASTM A-653 and A-924. Perforated inner liner shall consist of 1/8" perforations on 1/4" staggered centers corresponding to an overall open area of 23%.
2. When stainless steel is specified on contract documents, outershells of silencers manufactured using stainless steel type 304 or type 316 in accordance with ASTM A-240 shall be provided.
3. Absorption filler material shall be glass fiber of adequate density to meet the specified acoustic performance. Filler material density shall be high enough so as to eliminate voids caused by settling.
4. Glass fiber material shall conform to ASTM E84- 91a and NFPA 90A and not exceed flame spread and smoke developed ratings of 25/50.
5. Fiber retention fabric shall be 0.008" thick, 15.6 lbs ft³ density with an air permeability rate of 9.2 ft³/ft²-s.

Construction

1. Unless otherwise noted, all silencers shall be constructed per gauges in the following table:

Diameter (Inches)	Straight Silencer			Elbow Silencer	
	Inner	Outer	Baffle	Inner	Outer
3 - 14	28	28	22	24	24
16 - 24	26	26	22	24	22
26 - 42	24	24	22	NA	20
44 - 50	20	20	22	NA	18

2. The inner and outer shells of the straight silencers shall be spiral lockseam construction. The cavity formed by the two shells shall be filled with inorganic glass fiber sound absorption material. All silencers shall contain a fiber retention system which utilizes a non-woven polyester fabric integrated within the spiral seam of the inner shell and tightly secured to avoid fiberglass from eroding into the airstream.
3. The entry profile of the interior baffle shall be aerodynamically efficient thereby yielding minimum self-generated noise characteristics.
4. The outer shell of all straight silencers 8" diameter and larger shall be corrugated for added strength and rigidity. The corrugations also decrease the amount of surface area perpendicular to the noise source, adding to the effectiveness of the silencer and decreasing potential breakout noise.
5. Spiral seam slippage shall be prevented by means of a flat seam and a mechanically formed indentation evenly spaced along the spiral seam.
6. The inner and outer shells of all elbow silencers shall be a minimum of 5 gore construction. The inside of all outer shell gores shall be sealed to meet ASHRAE's Leakage Class 3 requirements. The cavity formed by the two shells shall be filled with inorganic glass fiber sound absorption material. The fiber retention system is integrated around the inner perforated shell and tightly secured to avoid fiberglass from eroding into the airstream.



Specification

7. All silencer ends shall come factory equipped with a double lipped, EPDM rubber gasket and shall be calibrated to the manufacturer's published dimensional tolerance standard. This ensures consistent performance with Lindab's Safe® Duct System. Gasket shall be classified by Underwriter's Laboratories to conform to ASTM E84-91a and NFPA 90A flame spread and smoke developed ratings of 25/50.
8. Silencers shall not leak or fail structurally when exposed to a maximum differential pressure of 8 inch water gauge.

Performance

1. ACOUSTIC: All silencer ratings shall be determined by testing performed in accordance with ASTM specification E477-96 which utilizes the duct-to-reverberant room test method and provides for airflow in both directions. Acoustic ratings shall include Dynamic Insertion Loss (DIL) and Self Generated Noise (SN) for both forward and reverse flow conditions. Data shall be presented for testing on the following sizes: 6", 12", 18", 24", 30", 36" and 42".
2. AERODYNAMIC: Static pressure drop of silencers shall not exceed those listed in the silencer schedule or specifications. Pressure drop data shall be presented for the same sizes as the acoustic data.

Certification

All silencer ratings shall be conducted by a nationally recognized acoustic test laboratory. The testing laboratory shall be completely independent of the manufacturer.

Straight silencers

SLGU

9



Dimensions

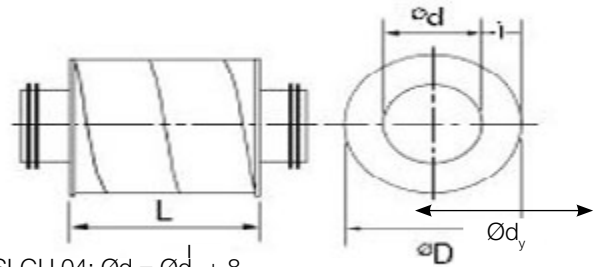

SLGU 04: $\text{Ød}_y = \text{Ød}_1 + 8$
SLGU 06: $\text{Ød}_y = \text{Ød}_1 + 12$

Description

The SLGU silencer is a straight through silencer with no obstructions to the air flow. It is available with 4" and 6" thick insulation.

Ordering example

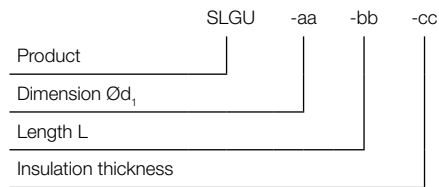

Straight silencers

SLGU 04

Acoustical Performance – Net Insertion Loss

Octave band	1	2	3	4	5	6	7	8	1	2	3	4	5	6	7	8	1	2	3	4	5	6	7	8	
Frequency (Hz)	63	125	250	500	1K	2K	4K	8K	63	125	250	500	1K	2K	4K	8K	63	125	250	500	1K	2K	4K	8K	
Ød ₁ (in)	Net Insertion Loss (Decibels)								Net Insertion Loss (Decibels)								Net Insertion Loss (Decibels)								
Velocity (fpm)	Net Insertion Loss (Decibels)								Net Insertion Loss (Decibels)								Net Insertion Loss (Decibels)								
L (in)	12								24								36								
3	-6000	7	8	12	17	19	26	22	19	9	13	21	29	33	39	32	23	10	18	29	41	46	51	42	27
	-4000	6	7	12	16	18	25	22	19	8	12	20	28	32	38	32	24	10	17	27	40	45	51	42	29
	-2000	6	7	11	16	18	25	22	20	8	12	18	27	32	38	33	26	10	16	25	38	45	51	43	31
	0	6	7	10	15	17	25	22	20	8	11	17	26	30	38	33	27	9	15	23	37	42	50	43	33
	+2000	5	7	10	15	17	24	22	20	7	11	16	26	29	35	32	27	9	14	21	36	40	45	42	33
	+4000	4	6	10	15	16	24	21	18	6	10	15	25	28	34	32	26	8	13	19	35	39	44	42	33
	+6000	3	5	10	14	16	24	20	17	6	9	14	24	27	33	30	25	8	12	18	34	37	42	40	33
4	-6000	6	7	11	15	17	23	19	16	8	12	19	27	30	34	28	21	9	17	27	39	43	45	37	24
	-4000	5	6	11	14	16	22	19	16	8	11	18	26	30	34	28	22	9	16	25	38	42	45	37	26
	-2000	5	6	10	14	16	22	19	17	7	10	17	26	29	34	28	23	9	15	23	36	42	45	38	28
	0	5	6	9	13	15	22	19	17	7	10	15	25	28	33	28	24	8	14	21	35	40	45	38	30
	+2000	4	6	9	13	14	21	19	17	6	9	15	25	27	32	28	24	7	13	20	34	38	43	37	30
	+4000	4	5	9	13	14	21	19	16	6	9	14	24	26	31	28	24	7	12	18	33	37	42	37	30
	+6000	3	5	9	13	14	21	19	15	5	8	13	23	25	30	28	24	6	11	17	32	35	40	36	30
5	-6000	5	6	10	13	15	20	16	13	7	11	18	25	28	29	24	17	8	16	26	37	41	39	32	21
	-4000	4	5	10	13	14	19	17	13	6	10	17	24	27	31	25	18	8	15	24	36	40	43	33	23
	-2000	4	5	9	12	14	19	17	14	6	9	15	23	26	31	25	19	7	14	22	34	39	43	34	25
	0	4	5	8	12	13	19	17	14	6	9	14	22	25	31	25	20	7	13	20	33	38	43	34	27
	+2000	4	5	8	11	12	18	17	14	5	8	13	22	24	30	25	20	6	12	19	32	36	42	33	27
	+4000	3	4	8	11	12	18	16	13	4	8	12	21	23	29	25	20	6	11	17	31	35	40	33	27
	+6000	2	4	7	11	12	18	16	12	3	7	12	20	22	27	24	19	5	10	17	29	33	36	32	27
6	-6000	4	5	8	11	13	17	13	10	6	10	16	23	26	25	20	14	7	15	24	35	38	32	26	17
	-4000	3	4	8	11	12	16	14	10	5	9	15	23	25	29	22	15	6	13	22	34	38	41	29	19
	-2000	3	4	7	10	11	16	14	10	4	8	14	21	24	29	22	16	5	12	21	32	36	41	29	21
	0	3	4	7	10	11	15	14	11	5	8	13	21	23	28	22	17	6	12	19	31	35	41	30	23
	+2000	3	3	6	9	10	15	14	11	4	7	12	20	22	28	22	17	5	11	18	30	33	40	29	23
	+4000	2	3	6	9	10	15	13	10	3	7	11	19	21	27	21	17	4	10	16	29	32	38	29	23
	+6000	1	3	5	8	9	15	13	9	2	6	11	17	20	24	20	16	3	9	16	26	30	32	27	23
7	-4000	4	9	15	21	24	27	20	14	5	13	21	31	36	37	27	19	6	16	28	41	47	47	33	23
	-3000	4	9	14	21	23	27	20	15	5	12	21	30	35	37	27	19	6	16	28	40	46	47	33	24
	-2000	4	9	13	20	23	27	20	15	5	12	20	30	34	37	27	20	6	15	27	39	45	47	33	25
	0	4	8	13	19	22	27	21	16	5	11	19	29	33	37	28	22	6	15	25	38	44	47	35	27
	+2000	4	7	12	18	21	26	20	16	4	10	18	28	31	36	27	22	5	14	24	37	42	45	33	27
	+3000	3	6	11	17	20	25	19	16	4	9	17	26	30	33	26	22	4	13	23	35	40	42	32	28
	+4000	2	6	11	17	19	23	19	15	3	9	16	25	29	31	25	22	4	12	22	34	38	38	32	28
8	-4000	4	9	14	20	23	25	18	14	5	12	21	29	33	33	24	18	5	15	27	37	43	41	30	22
	-3000	4	9	13	20	23	25	18	14	5	12	20	28	33	33	24	19	5	14	26	36	42	40	30	23
	-2000	3	9	12	19	22	25	19	15	4	12	19	27	32	33	25	20	5	14	26	35	41	40	30	24
	0	3	8	12	18	21	25	19	15	4	11	19	26	31	33	25	20	4	13	25	34	40	40	31	25
	+2000	3	7	12	17	20	24	18	15	4	10	18	26	30	31	24	20	4	12	24	34	39	38	30	25
	+3000	2	6	12	16	20	24	18	14	3	9	18	25	29	30	24	20	3	11	23	33	37	36	30	25
	+4000	2	5	11	16	19	23	18	14	3	8	17	24	27	29	24	20	3	11	22	32	35	35	29	26

10



Straight silencers

SLGU 04

Acoustical Performance – Net Insertion Loss

Octave band	1	2	3	4	5	6	7	8	1	2	3	4	5	6	7	8	1	2	3	4	5	6	7	8	
Frequency (Hz)	63	125	250	500	1K	2K	4K	8K	63	125	250	500	1K	2K	4K	8K	63	125	250	500	1K	2K	4K	8K	
Ød ₁ (in)	Velocity (fpm)	Net Insertion Loss (Decibels)								Net Insertion Loss (Decibels)								Net Insertion Loss (Decibels)							
L (in)		12								24								36							
9	-4000	4	8	14	18	23	23	16	13	4	11	20	26	31	30	22	16	4	13	26	34	40	37	27	20
	-3000	4	8	13	18	23	23	16	13	4	10	19	25	31	30	22	16	4	13	25	33	40	37	27	20
	-2000	3	8	12	17	21	23	17	13	3	10	18	25	30	30	22	17	4	13	25	32	39	37	28	21
	0	3	7	12	16	20	23	17	14	3	9	18	24	29	30	23	18	3	12	24	32	38	37	28	22
	+2000	3	7	12	16	19	23	16	14	3	9	17	23	28	29	22	18	3	11	23	31	37	36	27	23
	+3000	2	6	12	15	19	22	16	13	2	8	17	22	27	28	22	18	2	10	22	30	36	34	27	23
	+4000	2	5	11	15	18	22	16	13	2	7	16	22	26	28	21	18	2	10	21	30	34	34	26	23
10	-4000	3	7	13	16	22	21	14	11	3	9	19	24	30	27	19	14	3	11	24	31	37	33	24	17
	-3000	3	7	12	15	22	21	14	11	3	9	18	23	30	27	19	14	3	11	24	30	37	33	24	17
	-2000	2	7	12	15	20	21	14	11	3	9	18	22	28	27	20	15	3	11	23	29	36	33	25	18
	0	2	6	11	14	19	21	15	12	2	8	17	22	28	27	20	16	2	10	23	29	36	33	25	19
	+2000	2	6	11	14	18	21	14	12	2	8	17	21	27	27	19	16	2	9	22	28	35	33	24	20
	+3000	1	5	11	13	18	20	14	11	1	7	16	20	26	26	19	16	1	9	21	27	34	32	24	20
	+4000	1	5	10	13	17	20	14	11	1	7	15	20	25	26	19	16	1	8	20	27	33	32	23	20
12	-4000	0	4	12	12	19	16	11	8	0	6	18	19	26	21	14	10	0	8	23	25	33	26	16	12
	-3000	0	4	11	12	18	16	11	8	0	6	17	18	26	22	14	11	0	8	22	24	33	27	17	13
	-2000	0	4	11	12	18	16	12	9	0	6	17	18	25	22	15	11	0	8	22	24	32	27	18	13
	0	0	4	10	11	17	17	12	9	0	6	16	17	25	22	16	12	0	7	21	23	32	27	19	15
	+2000	0	4	10	11	17	17	12	9	0	6	15	17	24	23	15	12	0	7	20	22	31	28	18	15
	+3000	0	3	10	11	17	16	11	8	0	5	15	17	24	22	15	12	0	7	19	22	30	28	18	15
	+4000	0	3	9	10	16	16	11	8	0	5	14	16	23	22	15	12	0	7	18	21	30	28	18	15
L (in)		36								48								60							
14	-2000	3	6	12	14	18	16	14	11	4	8	16	19	22	19	16	14	4	9	19	23	25	21	18	16
	-1500	3	6	12	14	18	16	14	12	4	8	15	18	22	18	16	14	4	9	18	22	25	20	17	15
	-1000	3	6	12	14	18	16	14	11	4	8	15	18	22	18	16	13	4	9	18	22	25	20	17	15
	0	2	6	11	13	17	15	14	11	3	7	14	17	21	17	16	13	3	8	17	21	24	19	17	15
	+1000	2	5	11	13	17	15	14	11	3	7	14	17	21	17	15	12	3	8	16	20	24	18	16	13
	+2000	2	5	10	13	16	15	13	11	3	7	13	17	20	17	15	12	3	8	16	20	24	18	16	13
	+3000	2	5	10	13	16	14	12	10	3	7	13	16	20	16	14	12	3	8	16	19	24	18	16	13
16	-2000	2	6	13	16	19	17	15	12	3	7	17	20	23	19	17	14	4	9	20	24	28	22	19	16
	-1500	2	6	13	15	19	17	15	12	3	7	16	19	23	19	16	13	4	9	19	23	27	21	18	15
	-1000	2	6	13	15	19	17	15	11	3	7	16	19	23	19	16	13	4	9	19	23	27	21	18	15
	0	2	6	12	14	18	16	14	11	2	7	15	18	22	18	16	13	3	8	18	22	26	21	18	15
	+1000	2	5	11	14	18	16	14	11	2	6	14	17	22	18	16	12	3	7	17	21	26	20	17	13
	+2000	2	5	11	14	17	16	13	11	2	6	14	17	21	18	15	12	3	7	17	21	26	20	17	13
	+3000	2	5	11	14	17	15	13	10	2	6	13	17	21	17	15	11	3	7	16	20	26	20	17	13
18	-2000	1	6	14	17	20	17	15	12	3	7	18	21	25	20	17	14	4	8	21	25	30	22	19	15
	-1500	1	6	13	16	20	17	15	11	3	7	17	20	25	20	17	13	4	8	20	24	29	22	19	15
	-1000	1	6	13	16	19	17	15	11	2	7	16	20	24	20	17	13	3	8	19	24	29	22	19	15
	0	1	5	12	15	19	17	14	11	2	6	15	19	24	20	17	13	3	7	18	23	28	22	19	14
	+1000	1	5	11	14	18	16	14	10	2	6	14	18	23	19	16	12	3	6	17	22	28	22	18	13
	+2000	1	5	11	14	18	16	13	10	2	6	14	18	23	19	15	12	3	6	17	21	27	21	17	13
	+3000	1	5	11	14	18	16	13	9	2	6	14	18	23	19	15	11	3	6	16	21	27	21	17	13

Straight silencers

SLGU 04

Acoustical Performance – Net Insertion Loss

Octave band	1	2	3	4	5	6	7	8	1	2	3	4	5	6	7	8	1	2	3	4	5	6	7	8	
Frequency (Hz)	63	125	250	500	1K	2K	4K	8K	63	125	250	500	1K	2K	4K	8K	63	125	250	500	1K	2K	4K	8K	
Ød ₁ (in)	Velocity (fpm)	Net Insertion Loss (Decibels)								Net Insertion Loss (Decibels)								Net Insertion Loss (Decibels)							
L (in)		48								60								72							
20	-2000	3	7	16	19	23	18	16	13	4	8	19	23	27	21	18	15	5	9	23	27	32	23	20	16
	-1500	3	7	15	18	22	18	16	13	4	8	18	22	27	21	18	15	5	9	22	26	31	23	20	16
	-1000	2	7	15	18	22	18	16	12	3	8	18	22	27	21	18	14	4	9	21	26	31	23	20	16
	0	2	6	14	17	21	18	16	12	3	7	17	21	26	20	18	14	4	8	20	25	30	23	20	15
	+1000	2	5	13	16	21	18	15	11	3	6	16	20	26	20	17	13	4	7	19	24	30	23	19	15
	+2000	2	5	13	16	20	17	14	11	3	6	16	20	25	20	16	13	4	7	19	23	29	22	18	14
	+3000	2	5	12	16	20	17	14	11	3	6	15	19	25	19	16	13	4	7	18	23	29	22	18	14
22	-2000	3	6	14	16	20	17	15	12	4	8	17	21	24	20	17	14	5	9	21	25	28	22	19	16
	-1500	3	6	14	16	20	17	15	12	4	8	17	20	24	19	17	14	5	9	20	24	28	22	18	16
	-1000	3	6	13	16	20	17	15	12	3	8	16	20	24	19	17	14	4	9	19	24	28	22	18	16
	0	2	6	12	15	19	17	15	12	3	7	15	19	23	19	17	13	3	8	18	23	27	21	19	15
	+1000	2	5	12	15	19	16	15	11	3	6	15	19	23	19	16	13	3	8	18	23	27	21	18	15
	+2000	2	5	11	15	18	16	14	11	3	6	14	18	22	18	15	12	3	8	17	22	27	20	17	14
	+3000	2	5	11	15	18	16	13	10	3	6	14	18	22	18	15	12	3	8	17	21	27	20	17	14
24	-2000	3	6	12	14	18	16	14	11	4	8	16	19	22	19	16	14	4	9	19	23	25	21	18	16
	-1500	3	6	12	14	18	16	14	12	4	8	15	18	22	18	16	14	4	9	18	22	25	20	17	15
	-1000	3	6	12	14	18	16	14	11	4	8	15	18	22	18	16	13	4	9	18	22	25	20	17	15
	0	2	6	11	13	17	15	14	11	3	7	14	17	21	17	16	13	3	8	17	21	24	19	17	15
	+1000	2	5	11	13	17	15	14	11	3	7	14	17	21	17	16	13	3	8	17	21	24	19	17	15
	+2000	2	5	10	13	16	15	13	11	3	7	13	17	20	17	15	12	3	8	16	20	24	18	16	13
	+3000	2	5	10	13	16	14	12	10	3	7	13	16	20	16	14	12	3	8	16	19	24	18	16	13
L (in)		60								72								84							
26	-2000	3	7	15	18	19	17	15	13	4	8	19	23	23	20	17	15	4	10	22	27	26	22	19	17
	-1500	3	7	15	18	19	17	15	13	3	8	18	22	23	19	17	15	4	10	21	26	26	21	18	16
	-1000	3	7	15	18	19	17	15	13	4	8	18	22	23	19	17	15	4	9	21	26	26	21	18	16
	0	2	7	14	17	19	16	15	12	3	8	17	21	22	18	16	14	3	8	20	25	25	20	18	16
	+1000	2	6	14	17	18	16	15	12	3	8	17	21	22	18	16	14	3	9	20	25	25	20	18	16
	+2000	2	6	13	17	18	16	14	12	3	7	16	20	22	17	16	13	3	9	19	24	25	18	17	14
	+3000	2	6	13	16	18	15	14	11	3	7	16	20	22	17	16	13	3	9	19	23	25	19	17	14
28	-2000	2	6	14	17	16	15	14	12	3	7	17	21	20	18	16	14	3	8	20	25	23	20	17	15
	-1500	2	6	13	17	16	15	14	12	3	7	16	21	20	17	16	14	3	8	19	25	23	19	17	15
	-1000	2	6	13	17	16	15	14	12	3	7	16	21	19	17	16	13	3	8	19	25	22	19	17	15
	0	2	6	13	16	16	15	14	11	3	7	16	20	19	16	15	13	3	7	18	24	22	18	16	14
	+1000	1	6	12	16	15	14	13	11	2	7	15	20	19	16	15	13	2	7	18	24	22	18	16	14
	+2000	2	5	12	16	15	14	14	11	2	6	15	20	18	16	15	12	2	7	17	23	21	17	16	13
	+3000	2	5	12	16	15	14	13	11	3	6	15	19	18	15	14	12	3	7	18	22	21	17	16	13
30	-1750	2	6	15	18	15	15	14	12	3	7	18	22	19	17	16	14	3	8	20	26	22	19	17	15
	-1500	2	6	14	18	15	15	14	12	2	7	17	22	19	17	16	14	2	8	20	26	22	19	17	15
	-1000	2	6	14	18	15	15	14	12	3	7	17	22	18	17	16	14	3	7	20	26	21	18	17	15
	0	2	6	14	18	15	15	14	11	3	7	17	22	18	16	15	13	3	7	19	25	21	17	16	14
	+1000	1	6	13	17	14	14	13	11	2	7	16	21	18	16	15	13	2	7	19	25	21	17	16	14
	+1500	2	5	13	17	14	14	14	11	2	6	16	21	17	15	15	12	2	7	18	25	20	16	16	13
	+2000	2	5	13	17	14	14	13	11	3	6	16	21	17	15	15	12	3	7	19	24	19	16	16	13



Straight silencers

SLGU 04

Acoustical Performance – Net Insertion Loss

Octave band	1	2	3	4	5	6	7	8	1	2	3	4	5	6	7	8	1	2	3	4	5	6	7	8	
Frequency (Hz)	63	125	250	500	1K	2K	4K	8K	63	125	250	500	1K	2K	4K	8K	63	125	250	500	1K	2K	4K	8K	
Ød ₁ (in)	Net Insertion Loss (Decibels)								Net Insertion Loss (Decibels)								Net Insertion Loss (Decibels)								
L (in)	72								84								96								
32	-1750	2	7	17	20	17	15	14	12	3	8	19	24	20	17	16	14	3	8	21	28	22	19	17	15
	-1500	2	7	16	20	17	15	14	12	2	8	19	24	20	17	16	14	2	8	22	28	22	19	17	15
	-1000	2	6	16	20	17	15	14	12	3	7	19	24	19	17	16	14	3	7	22	28	21	18	17	15
	0	2	6	16	20	17	15	14	11	2	7	18	23	19	16	15	13	3	7	20	27	21	17	16	14
	+1000	1	6	15	19	16	14	13	11	2	7	18	23	19	15	15	13	2	7	21	27	21	17	16	14
	+1500	2	6	15	19	16	13	13	11	2	7	17	23	18	15	14	12	2	8	20	27	20	16	15	13
	+2000	2	6	15	19	15	13	13	11	3	7	18	23	17	15	14	12	3	8	21	26	19	16	16	13
34	-1750	2	6	16	19	15	14	13	11	2	7	18	22	17	15	14	12	3	8	20	25	19	17	16	14
	-1500	1	6	15	19	16	14	13	11	2	7	18	22	17	15	14	12	2	8	20	25	19	17	16	14
	-1000	1	6	15	19	15	14	13	11	2	7	18	22	17	15	14	12	3	7	20	25	19	17	16	14
	0	1	6	15	19	15	14	12	10	2	6	17	22	17	15	14	11	3	7	19	25	19	16	15	13
	+1000	1	6	15	18	15	13	12	10	2	7	17	21	16	14	13	11	2	7	19	25	18	15	15	13
	+1500	1	5	15	18	14	12	12	9	2	6	17	21	16	13	13	11	2	7	19	25	18	14	14	12
	+2000	2	5	14	18	14	12	12	9	2	6	17	21	16	13	13	11	3	7	19	25	17	14	14	12
36	-1250	1	6	15	17	13	12	11	9	2	7	17	20	15	14	13	11	2	7	19	23	16	15	14	12
	-1000	1	6	14	17	14	12	11	9	2	7	17	20	15	14	13	11	2	7	19	23	16	15	14	12
	-750	0	6	14	17	14	12	11	9	2	7	17	20	15	14	13	11	3	7	19	23	16	15	14	12
	0	0	5	14	17	14	13	11	8	1	6	16	20	15	14	13	10	2	7	18	23	16	15	14	12
	+1000	1	6	14	16	13	11	10	8	2	7	16	20	14	12	12	10	2	7	18	23	14	13	13	11
	+1250	1	5	14	16	13	10	10	8	2	6	16	20	14	12	11	10	2	7	18	23	15	13	12	11
	+1500	1	5	13	16	13	10	10	8	2	6	16	20	14	12	11	10	2	7	18	23	15	13	12	11
L (in)	84								96																
38	-1250	2	7	16	19	14	13	11	9	2	7	18	22	16	15	13	11	2	7	18	22	16	15	13	11
	-1000	2	6	15	19	14	13	11	9	2	7	18	22	16	15	13	11	2	7	18	22	16	15	13	11
	-750	2	6	15	19	14	13	11	9	3	7	18	22	16	15	13	11	3	7	18	22	16	15	13	11
	0	1	6	15	19	14	13	12	10	2	7	17	22	16	15	13	12	2	7	17	22	16	15	13	12
	+1000	2	6	15	18	13	11	10	9	2	7	17	22	14	13	12	11	2	7	17	22	14	13	12	11
	+1250	2	6	15	18	13	11	10	9	2	7	17	22	15	12	11	10	2	7	17	22	15	12	11	10
	+1500	2	6	15	18	13	11	10	9	2	7	17	22	15	12	11	10	2	7	17	22	15	12	11	10
40	-1250	2	7	14	18	13	12	10	8	3	7	17	20	15	14	12	10	3	7	17	20	15	14	12	10
	-1000	2	6	14	17	13	12	10	8	2	7	17	20	15	14	13	10	2	7	17	20	15	14	13	10
	-750	2	6	14	18	14	13	10	8	2	7	17	20	15	14	13	11	2	7	17	20	15	14	13	11
	0	2	6	14	17	13	13	11	9	2	6	16	20	15	14	13	11	2	6	16	20	15	14	13	11
	+1000	2	6	14	17	13	11	9	8	2	6	16	20	14	12	11	10	2	6	16	20	14	12	11	10
	+1250	2	6	14	17	13	11	9	8	2	6	16	20	14	12	11	10	2	6	16	20	14	12	11	10
	+1500	2	6	14	17	13	10	9	8	2	6	16	20	14	12	10	10	2	6	16	20	14	12	10	10
42	-1000	2	7	13	17	12	11	9	6	3	7	16	19	15	14	11	9	3	7	16	19	15	14	11	9
	-750	2	6	13	16	12	11	9	6	2	7	16	19	15	14	12	9	2	7	16	19	15	14	12	9
	-500	2	6	13	17	13	12	9	7	2	7	16	19	15	14	12	10	2	7	16	19	15	14	12	10
	0	2	6	13	16	12	12	10	9	2	6	15	19	15	14	12	11	2	6	15	19	15	14	12	11
	+750	2	6	13	16	12	10	8	7	2	6	15	19	14	12	10	10	2	6	15	19	14	12	10	10
	+1000	2	6	13	16	12	10	8	7	2	6	15	19	14	11	10	9	2	6	15	19	14	11	10	9
	+1100	2	6	13	16	12	9	8	7	2	6	15	19	14	11	9	9	2	6	15	19	14	11	9	9



Straight silencers

SLGU 04

Acoustical Performance – Net Insertion Loss

Octave band	1	2	3	4	5	6	7	8	1	2	3	4	5	6	7	8	
Frequency (Hz)	63	125	250	500	1K	2K	4K	8K	63	125	250	500	1K	2K	4K	8K	
Ød ₁ (in)	Velocity (fpm)	Net Insertion Loss (Decibels)								Net Insertion Loss (Decibels)							
L(in)		84								96							
44	-1000	2	7	12	16	11	11	8	5	2	7	15	18	14	13	10	8
	-750	2	6	12	15	11	11	8	5	2	7	15	18	14	14	11	8
	-500	2	6	12	16	12	12	8	6	2	7	15	18	15	14	11	9
	0	2	6	12	15	12	12	9	8	2	6	14	18	15	14	11	10
	+750	2	6	12	15	12	10	7	6	2	6	14	18	14	12	9	9
	+1000	2	6	12	15	11	10	7	6	2	6	14	18	13	11	9	8
	+1100	2	6	12	15	11	9	7	6	2	6	14	18	13	11	9	8
46	-1000	1	6	11	15	11	10	7	5	2	6	13	18	14	13	9	7
	-750	1	5	11	15	11	10	7	5	2	6	14	17	14	13	9	8
	-500	2	5	11	15	11	11	7	6	2	6	14	17	14	13	10	8
	0	2	5	11	14	11	11	8	7	2	6	14	17	14	13	10	9
	+750	1	5	11	14	11	10	7	6	2	5	14	17	13	12	9	9
	+1000	1	5	11	14	11	9	7	6	2	5	13	17	13	11	9	8
	+1100	1	5	11	14	11	8	7	6	1	5	13	17	13	11	8	8
48	-1000	1	6	10	14	10	10	6	4	1	6	12	17	13	12	8	6
	-750	1	5	10	14	10	10	6	4	2	6	13	16	13	13	8	7
	-500	2	5	10	14	10	11	6	5	2	6	13	16	14	13	9	7
	0	2	5	10	13	11	11	7	6	2	6	13	16	14	13	9	8
	+500	1	5	10	13	11	10	6	5	2	5	13	16	13	12	8	8
	+750	1	5	10	13	10	9	6	5	2	5	12	16	12	11	8	7
	+1000	1	5	10	13	10	8	6	5	1	5	12	16	12	11	8	7
50	-1000	1	6	11	15	10	10	7	4	1	6	13	17	13	12	9	7
	-750	1	5	11	14	10	10	7	4	2	6	14	17	13	13	9	7
	-500	2	5	11	15	11	11	7	5	2	6	14	17	14	13	10	8
	0	2	5	11	14	11	11	8	7	2	6	13	17	14	13	10	9
	+500	1	5	11	14	11	10	6	5	2	5	13	17	13	12	8	8
	+750	1	5	11	14	10	9	6	5	2	5	13	17	12	11	8	7
	+1000	1	5	11	14	10	8	6	5	1	5	13	17	12	11	8	7

Notes:

1. Net insertion loss, self-generated noise and pressure drop data were obtained through tests conducted by an independent testing laboratory in accordance with ASTM Standard E477-96, entitled "Standard Method of Testing Duct Liner Materials and Prefabricated Silencers for Acoustical and Airflow Performance." Test specimens whose inside diameters correspond to 6", 12", 18", 24", 30", 36", and 42" and whose lengths correspond to the minimum and maximum lengths catalogued were tested and reported. All data presented for other diameters and lengths were interpolated or extrapolated.
2. Velocity, indicated as fpm, is determined by dividing the air flow through the silencer (ft³/min) by the cross sectional area of the silencer face (ft²) calculated using the silencer clear inside diameter. Return/exhaust air is indicated as (-) fpm and supply air is indicated as (+) fpm. 0 fpm is the "no flow" condition.
3. The pressure drop performance data obtained from ASTM E477-96 "Standard Method of Testing Duct Liner Materials and Prefabricated Silencers for Acoustical and Airflow Performance" are tested at simulated ideal ducted inlet and ducted outlet conditions. Any deviations from these ideal conditions on actual silencer installations should be accounted for in the form of additional pressure loss.
4. The self-generated noise for elbow silencers and straight silencers without a baffle is too low to be measured by ASTM E477-96. The measurements obtained for these silencers are equal to or less than the corresponding single wall duct reference condition or within +/- 10dB per ASTM E477-96 section 9.1.2.



Straight silencers

SLGU 06

Acoustical Performance – Net Insertion Loss

Octave band	1	2	3	4	5	6	7	8	1	2	3	4	5	6	7	8	1	2	3	4	5	6	7	8	
Frequency (Hz)	63	125	250	500	1K	2K	4K	8K	63	125	250	500	1K	2K	4K	8K	63	125	250	500	1K	2K	4K	8K	
Ød ₁ (in)	Velocity (fpm)	Net Insertion Loss (Decibels)								Net Insertion Loss (Decibels)								Net Insertion Loss (Decibels)							
L (in)		12								24								36							
3	-6000	7	8	12	17	19	26	22	19	9	13	21	29	33	39	32	23	10	18	29	41	46	51	42	27
	-4000	6	7	12	16	18	25	22	19	8	12	20	28	32	38	32	24	10	17	27	40	45	51	42	29
	-2000	6	7	11	16	18	25	22	20	8	12	18	27	32	38	33	26	10	16	25	38	45	51	43	31
	0	6	7	10	15	17	25	22	20	8	11	17	26	30	38	33	27	9	15	23	37	42	50	43	33
	+2000	5	7	10	15	17	24	22	20	7	11	16	26	29	35	32	27	9	14	21	36	40	45	42	33
	+4000	4	6	10	15	16	24	21	18	6	10	15	25	28	34	32	26	8	13	19	35	39	44	42	33
	+6000	3	5	10	14	16	24	20	17	6	9	14	24	27	33	30	25	8	12	18	34	37	42	40	33
4	-6000	6	7	11	15	17	23	19	16	8	12	19	27	30	34	28	21	9	17	27	39	43	45	37	24
	-4000	5	6	11	14	16	22	19	16	8	11	18	26	30	34	28	22	9	16	25	38	42	45	37	26
	-2000	5	6	10	14	16	22	19	17	7	10	17	26	29	34	28	23	9	15	23	36	42	45	38	28
	0	5	6	9	13	15	22	19	17	7	10	15	25	28	33	28	24	8	14	21	35	40	45	38	30
	+2000	4	6	9	13	14	21	19	17	6	9	15	25	27	32	28	24	7	13	20	34	38	43	37	30
	+4000	4	5	9	13	14	21	19	16	6	9	14	24	26	31	28	24	7	12	18	33	37	42	37	30
	+6000	3	5	9	13	14	21	19	15	5	8	13	23	25	30	28	24	6	11	17	32	35	40	36	30
5	-6000	5	6	10	13	15	20	16	13	7	11	18	25	28	29	24	17	8	16	26	37	41	39	32	21
	-4000	4	5	10	13	14	19	17	13	6	10	17	24	27	31	25	18	8	15	24	36	40	43	33	23
	-2000	4	5	9	12	14	19	17	14	6	9	15	23	26	31	25	19	7	14	22	34	39	43	34	25
	0	4	5	8	12	13	19	17	14	6	9	14	22	25	31	25	20	7	13	20	33	38	43	34	27
	+2000	4	5	8	11	12	18	17	14	5	8	13	22	24	30	25	20	6	12	19	32	36	42	33	27
	+4000	3	4	8	11	12	18	16	13	4	8	12	21	23	29	25	20	6	11	17	31	35	40	33	27
	+6000	2	4	7	11	12	18	16	12	3	7	12	20	22	27	24	19	5	10	17	29	33	36	32	27
6	-6000	4	5	8	11	13	17	13	10	6	10	16	23	26	25	20	14	7	15	24	35	38	32	26	17
	-4000	3	4	8	11	12	16	14	10	5	9	15	23	25	29	22	15	6	13	22	34	38	41	29	19
	-2000	3	4	7	10	11	16	14	10	4	8	14	21	24	29	22	16	5	12	21	32	36	41	29	21
	0	3	4	7	10	11	15	14	11	5	8	13	21	23	28	22	17	6	12	19	31	35	41	30	23
	+2000	3	3	6	9	10	15	14	11	4	7	12	20	22	28	22	17	5	11	18	30	33	40	29	23
	+4000	2	3	6	9	10	15	13	10	3	7	11	19	21	27	21	17	4	10	16	29	32	38	29	23
	+6000	1	3	5	8	9	15	13	9	2	6	11	17	20	24	20	16	3	9	16	26	30	32	27	23
7	-4000	4	9	15	21	24	27	20	14	5	13	21	31	36	37	27	19	6	16	28	41	47	47	33	23
	-3000	4	9	14	21	23	27	20	15	5	12	21	30	35	37	27	19	6	16	28	40	46	47	33	24
	-2000	4	9	13	20	23	27	20	15	5	12	20	30	34	37	27	20	6	15	27	39	45	47	33	25
	0	4	8	13	19	22	27	21	16	5	11	19	29	33	37	28	22	6	15	25	38	44	47	35	27
	+2000	4	7	12	18	21	26	20	16	4	10	18	28	31	36	27	22	5	14	24	37	42	45	33	27
	+3000	3	6	11	17	20	25	19	16	4	9	17	26	30	33	26	22	4	13	23	35	40	42	32	28
	+4000	2	6	11	17	19	23	19	15	3	9	16	25	29	31	25	22	4	12	22	34	38	38	32	28
8	-4000	4	9	14	20	23	25	18	14	5	12	21	29	33	33	24	18	5	15	27	37	43	41	30	22
	-3000	4	9	13	20	23	25	18	14	5	12	20	28	33	33	24	19	5	14	26	36	42	40	30	23
	-2000	3	9	12	19	22	25	19	15	4	12	19	27	32	33	25	20	5	14	26	35	41	40	30	24
	0	3	8	12	18	21	25	19	15	4	11	19	26	31	33	25	20	4	13	25	34	40	40	31	25
	+2000	3	7	12	17	20	24	18	15	4	10	18	26	30	31	24	20	4	12	24	34	39	38	30	25
	+3000	2	6	12	16	20	24	18	14	3	9	18	25	29	30	24	20	3	11	23	33	37	36	30	25
	+4000	2	5	11	16	19	23	18	14	3	8	17	24	27	29	24	20	3	11	22	32	35	35	29	26
8	-4000	4	9	14	20	23	25	18	14	5	12	21	29	33	33	24	18	5	15	27	37	43	41	30	22
	-3000	4	9	13	20	23	25	18	14	5	12	20	28	33	33	24	19	5	14	26	36	42	40	30	23
	-2000	3	9	12	19	22	25	19	15	4	12	19	27	32	33	25	20	5	14	26	35	41	40	30	24
	0	3	8	12	18	21	25	19	15	4	11	19	26	31	33	25	20	4	13	25	34	40	40	31	25
	+2000	3	7	12	17	20	24	18	15	4	10	18	26	30	31	24	20	4	12	24	34	39	38	30	25
	+3000	2	6	12	16	20	24	18	14	3	9	18	25	29	30	24	20	3	11	23	33	37	36	30	25
	+4000	2	5	11	16	19	23	18	14	3	8	17	24	27	29	24	20	3	11	22	32	35	35	29	26



Straight silencers

SLGU 06

Acoustical Performance – Net Insertion Loss

Octave band	1	2	3	4	5	6	7	8	1	2	3	4	5	6	7	8	1	2	3	4	5	6	7	8	
Frequency (Hz)	63	125	250	500	1K	2K	4K	8K	63	125	250	500	1K	2K	4K	8K	63	125	250	500	1K	2K	4K	8K	
Ød ₁ (in)	Velocity (fpm)	Net Insertion Loss (Decibels)								Net Insertion Loss (Decibels)								Net Insertion Loss (Decibels)							
L (in)		12								24								36							
9	-4000	4	8	14	18	23	23	16	13	4	11	20	26	31	30	22	16	4	13	26	34	40	37	27	20
	-3000	4	8	13	18	23	23	16	13	4	10	19	25	31	30	22	16	4	13	25	33	40	37	27	20
	-2000	3	8	12	17	21	23	17	13	3	10	18	25	30	30	22	17	4	13	25	32	39	37	28	21
	0	3	7	12	16	20	23	17	14	3	9	18	24	29	30	23	18	3	12	24	32	38	37	28	22
	+2000	3	7	12	16	19	23	16	14	3	9	17	23	28	29	22	18	3	11	23	31	37	36	27	23
	+3000	2	6	12	15	19	22	16	13	2	8	17	22	27	28	22	18	2	10	22	30	36	34	27	23
	+4000	2	5	11	15	18	22	16	13	2	7	16	22	26	28	21	18	2	10	21	30	34	34	26	23
10	-4000	3	7	13	16	22	21	14	11	3	9	19	24	30	27	19	14	3	11	24	31	37	33	24	17
	-3000	3	7	12	15	22	21	14	11	3	9	18	23	30	27	19	14	3	11	24	30	37	33	24	17
	-2000	2	7	12	15	20	21	14	11	3	9	18	22	28	27	20	15	3	11	23	29	36	33	25	18
	0	2	6	11	14	19	21	15	12	2	8	17	22	28	27	20	16	2	10	23	29	36	33	25	19
	+2000	2	6	11	14	18	21	14	12	2	8	17	21	27	27	19	16	2	9	22	28	35	33	24	20
	+3000	1	5	11	13	18	20	14	11	1	7	16	20	26	26	19	16	1	9	21	27	34	32	24	20
	+4000	1	5	10	13	17	20	14	11	1	7	15	20	25	26	19	16	1	8	20	27	33	32	23	20
12	-4000	0	4	12	12	19	16	11	8	0	6	18	19	26	21	14	10	0	8	23	25	33	26	16	12
	-3000	0	4	11	12	18	16	11	8	0	6	17	18	26	22	14	11	0	8	22	24	33	27	17	13
	-2000	0	4	11	12	18	16	12	9	0	6	17	18	25	22	15	11	0	8	22	24	32	27	18	13
	0	0	4	10	11	17	17	12	9	0	6	16	17	25	22	16	12	0	7	21	23	32	27	19	15
	+2000	0	4	10	11	17	17	12	9	0	6	15	17	24	23	15	12	0	7	20	22	31	28	18	15
	+3000	0	3	10	11	17	16	11	8	0	5	15	17	24	22	15	12	0	7	19	22	30	28	18	15
	+4000	0	3	9	10	16	16	11	8	0	5	14	16	23	22	15	12	0	7	18	21	30	28	18	15
L (in)		36								48								60							
14	-2000	3	6	12	14	18	16	14	11	4	8	16	19	22	19	16	14	4	9	19	23	25	21	18	16
	-1500	3	6	12	14	18	16	14	12	4	8	15	18	22	18	16	14	4	9	18	22	25	20	17	15
	-1000	3	6	12	14	18	16	14	11	4	8	15	18	22	18	16	13	4	9	18	22	25	20	17	15
	0	2	6	11	13	17	15	14	11	3	7	14	17	21	17	16	13	3	8	17	21	24	19	17	15
	+1000	2	5	11	13	17	15	14	11	3	7	14	17	21	17	15	12	3	8	16	20	24	18	16	13
	+2000	2	5	10	13	16	15	13	11	3	7	13	17	20	17	15	12	3	8	16	20	24	18	16	13
	+3000	2	5	10	13	16	14	12	10	3	7	13	16	20	16	14	12	3	8	16	19	24	18	16	13
16	-2000	2	6	13	16	19	17	15	12	3	7	17	20	23	19	17	14	4	9	20	24	28	22	19	16
	-1500	2	6	13	15	19	17	15	12	3	7	16	19	23	19	16	13	4	9	19	23	27	21	18	15
	-1000	2	6	13	15	19	17	15	11	3	7	16	19	23	19	16	13	4	9	19	23	27	21	18	15
	0	2	6	12	14	18	16	14	11	2	7	15	18	22	18	16	13	3	8	18	22	26	21	18	15
	+1000	2	5	11	14	18	16	14	11	2	6	14	17	22	18	16	12	3	7	17	21	26	20	17	13
	+2000	2	5	11	14	17	16	13	11	2	6	14	17	21	18	15	12	3	7	17	21	26	20	17	13
	+3000	2	5	11	14	17	15	13	10	2	6	13	17	21	17	15	11	3	7	16	20	26	20	17	13
18	-2000	1	6	14	17	20	17	15	12	3	7	18	21	25	20	17	14	4	8	21	25	30	22	19	15
	-1500	1	6	13	16	20	17	15	11	3	7	17	20	25	20	17	13	4	8	20	24	29	22	19	15
	-1000	1	6	13	16	19	17	15	11	2	7	16	20	24	20	17	13	3	8	19	24	29	22	19	15
	0	1	5	12	15	19	17	14	11	2	6	15	19	24	20	17	13	3	7	18	23	28	22	19	14
	+1000	1	5	11	14	18	16	14	10	2	6	14	18	23	19	16	12	3	6	17	22	28	22	18	13
	+2000	1	5	11	14	18	16	13	10	2	6	14	18	23	19	15	12	3	6	17	21	27	21	17	13
	+3000	1	5	11	14	18	16	13	9	2	6	14	18	23	19	15	11	3	6	16	21	27	21	17	13



Straight silencers

SLGU 06

Acoustical Performance – Net Insertion Loss

Octave band	1	2	3	4	5	6	7	8	1	2	3	4	5	6	7	8	1	2	3	4	5	6	7	8	
Frequency (Hz)	63	125	250	500	1K	2K	4K	8K	63	125	250	500	1K	2K	4K	8K	63	125	250	500	1K	2K	4K	8K	
Ød ₁ (in)	Velocity (fpm)	Net Insertion Loss (Decibels)								Net Insertion Loss (Decibels)								Net Insertion Loss (Decibels)							
L (in)		48								60								72							
20	-2000	3	7	16	19	23	18	16	13	4	8	19	23	27	21	18	15	5	9	23	27	32	23	20	16
	-1500	3	7	15	18	22	18	16	13	4	8	18	22	27	21	18	15	5	9	22	26	31	23	20	16
	-1000	2	7	15	18	22	18	16	12	3	8	18	22	27	21	18	14	4	9	21	26	31	23	20	16
	0	2	6	14	17	21	18	16	12	3	7	17	21	26	20	18	14	4	8	20	25	30	23	20	15
	+1000	2	5	13	16	21	18	15	11	3	6	16	20	26	20	17	13	4	7	19	24	30	23	19	15
	+2000	2	5	13	16	20	17	14	11	3	6	16	20	25	20	16	13	4	7	19	23	29	22	18	14
	+3000	2	5	12	16	20	17	14	11	3	6	15	19	25	19	16	13	4	7	18	23	29	22	18	14
22	-2000	3	6	14	16	20	17	15	12	4	8	17	21	24	20	17	14	5	9	21	25	28	22	19	16
	-1500	3	6	14	16	20	17	15	12	4	8	17	20	24	19	17	14	5	9	20	24	28	22	18	16
	-1000	3	6	13	16	20	17	15	12	3	8	16	20	24	19	17	14	4	9	19	24	28	22	18	16
	0	2	6	12	15	19	17	15	12	3	7	15	19	23	19	17	13	3	8	18	23	27	21	19	15
	+1000	2	5	12	15	19	16	15	11	3	6	15	19	23	19	16	13	3	8	18	23	27	21	18	15
	+2000	2	5	11	15	18	16	14	11	3	6	14	18	22	18	15	12	3	8	17	22	27	20	17	14
	+3000	2	5	11	15	18	16	13	10	3	6	14	18	22	18	15	12	3	8	17	21	27	20	17	14
24	-2000	3	6	12	14	18	16	14	11	4	8	16	19	22	19	16	14	4	9	19	23	25	21	18	16
	-1500	3	6	12	14	18	16	14	12	4	8	15	18	22	18	16	14	4	9	18	22	25	20	17	15
	-1000	3	6	12	14	18	16	14	11	4	8	15	18	22	18	16	13	4	9	18	22	25	20	17	15
	0	2	6	11	13	17	15	14	11	3	7	14	17	21	17	16	13	3	8	17	21	24	19	17	15
	+1000	2	5	11	13	17	15	14	11	3	7	14	17	21	17	16	13	3	8	17	21	24	19	17	15
	+2000	2	5	10	13	16	15	13	11	3	7	13	17	20	17	15	12	3	8	16	20	24	18	16	13
	+3000	2	5	10	13	16	14	12	10	3	7	13	16	20	16	14	12	3	8	16	19	24	18	16	13
L (in)		60								72								84							
26	-2000	3	7	15	18	19	17	15	13	4	8	19	23	23	20	17	15	4	10	22	27	26	22	19	17
	-1500	3	7	15	18	19	17	15	13	3	8	18	22	23	19	17	15	4	10	21	26	26	21	18	16
	-1000	3	7	15	18	19	17	15	13	4	8	18	22	23	19	17	15	4	9	21	26	26	21	18	16
	0	2	7	14	17	19	16	15	12	3	8	17	21	22	18	16	14	3	8	20	25	25	20	18	16
	+1000	2	6	14	17	18	16	15	12	3	8	17	21	22	18	16	14	3	9	20	25	25	20	18	16
	+2000	2	6	13	17	18	16	14	12	3	7	16	20	22	17	16	13	3	9	19	24	25	18	17	14
	+3000	2	6	13	16	18	15	14	11	3	7	16	20	22	17	16	13	3	9	19	23	25	19	17	14
28	-2000	2	6	14	17	16	15	14	12	3	7	17	21	20	18	16	14	3	8	20	25	23	20	17	15
	-1500	2	6	13	17	16	15	14	12	3	7	16	21	20	17	16	14	3	8	19	25	23	19	17	15
	-1000	2	6	13	17	16	15	14	12	3	7	16	21	19	17	16	13	3	8	19	25	22	19	17	15
	0	2	6	13	16	16	15	14	11	3	7	16	20	19	16	15	13	3	7	18	24	22	18	16	14
	+1000	1	6	12	16	15	14	13	11	2	7	15	20	19	16	15	13	2	7	18	24	22	18	16	14
	+2000	2	5	12	16	15	14	14	11	2	6	15	20	18	16	15	12	2	7	17	23	21	17	16	13
	+3000	2	5	12	16	15	14	13	11	3	6	15	19	18	15	14	12	3	7	18	22	21	17	16	13
30	-1750	2	6	15	18	15	15	14	12	3	7	18	22	19	17	16	14	3	8	20	26	22	19	17	15
	-1500	2	6	14	18	15	15	14	12	2	7	17	22	19	17	16	14	2	8	20	26	22	19	17	15
	-1000	2	6	14	18	15	15	14	12	3	7	17	22	18	17	16	14	3	7	20	26	21	18	17	15
	0	2	6	14	18	15	15	14	11	3	7	17	22	18	16	15	13	3	7	19	25	21	17	16	14
	+1000	1	6	13	17	14	14	13	11	2	7	16	21	18	16	15	13	2	7	19	25	21	17	16	14
	+1500	2	5	13	17	14	14	14	11	2	6	16	21	17	15	15	12	2	7	18	25	20	16	16	13
	+2000	2	5	13	17	14	14	13	11	3	6	16	21	17	15	15	12	3	7	19	24	19	16	16	13



Straight silencers

SLGU 06

Acoustical Performance – Net Insertion Loss

Octave band	1	2	3	4	5	6	7	8	1	2	3	4	5	6	7	8	1	2	3	4	5	6	7	8	
Frequency (Hz)	63	125	250	500	1K	2K	4K	8K	63	125	250	500	1K	2K	4K	8K	63	125	250	500	1K	2K	4K	8K	
Ød ₁ (in)	Velocity (fpm)	Net Insertion Loss (Decibels)								Net Insertion Loss (Decibels)								Net Insertion Loss (Decibels)							
L (in)		72								84								96							
32	-1750	2	7	17	20	17	15	14	12	3	8	19	24	20	17	16	14	3	8	21	28	22	19	17	15
	-1500	2	7	16	20	17	15	14	12	2	8	19	24	20	17	16	14	2	8	22	28	22	19	17	15
	-1000	2	6	16	20	17	15	14	12	3	7	19	24	19	17	16	14	3	7	22	28	21	18	17	15
	0	2	6	16	20	17	15	14	11	2	7	18	23	19	16	15	13	3	7	20	27	21	17	16	14
	+1000	1	6	15	19	16	14	13	11	2	7	18	23	19	15	15	13	2	7	21	27	21	17	16	14
	+1500	2	6	15	19	16	13	13	11	2	7	17	23	18	15	14	12	2	8	20	27	20	16	15	13
	+2000	2	6	15	19	15	13	13	11	3	7	18	23	17	15	14	12	3	8	21	26	19	16	16	13
34	-1750	2	6	16	19	15	14	13	11	2	7	18	22	17	15	14	12	3	8	20	25	19	17	16	14
	-1500	1	6	15	19	16	14	13	11	2	7	18	22	17	15	14	12	2	8	20	25	19	17	16	14
	-1000	1	6	15	19	15	14	13	11	2	7	18	22	17	15	14	12	3	7	20	25	19	17	16	14
	0	1	6	15	19	15	14	12	10	2	6	17	22	17	15	14	11	3	7	19	25	19	16	15	13
	+1000	1	6	15	18	15	13	12	10	2	7	17	21	16	14	13	11	2	7	19	25	18	15	15	13
	+1500	1	5	15	18	14	12	12	9	2	6	17	21	16	13	13	11	2	7	19	25	18	14	14	12
	+2000	2	5	14	18	14	12	12	9	2	6	17	21	16	13	13	11	3	7	19	25	17	14	14	12
36	-1250	1	6	15	17	13	12	11	9	2	7	17	20	15	14	13	11	2	7	19	23	16	15	14	12
	-1000	1	6	14	17	14	12	11	9	2	7	17	20	15	14	13	11	2	7	19	23	16	15	14	12
	-750	0	6	14	17	14	12	11	9	2	7	17	20	15	14	13	11	3	7	19	23	16	15	14	12
	0	0	5	14	17	14	13	11	8	1	6	16	20	15	14	13	10	2	7	18	23	16	15	14	12
	+1000	1	6	14	16	13	11	10	8	2	7	16	20	14	12	12	10	2	7	18	23	14	13	13	11
	+1250	1	5	14	16	13	10	10	8	2	6	16	20	14	12	11	10	2	7	18	23	15	13	12	11
	+1500	1	5	13	16	13	10	10	8	2	6	16	20	14	12	11	10	2	7	18	23	15	13	12	11
38	L (in)	84								96															
	-1250	2	7	16	19	14	13	11	9	2	7	18	22	16	15	13	11								
	-1000	2	6	15	19	14	13	11	9	2	7	18	22	16	15	13	11								
	-750	2	6	15	19	14	13	11	9	3	7	18	22	16	15	13	11								
	0	1	6	15	19	14	13	12	10	2	7	17	22	16	15	13	12								
	+1000	2	6	15	18	13	11	10	9	2	7	17	22	14	13	12	11								
	+1250	2	6	15	18	13	11	10	9	2	7	17	22	15	12	11	10								
40	+1500	2	6	15	18	13	11	10	9	2	7	17	22	15	12	11	10								
	-1250	2	7	14	18	13	12	10	8	3	7	17	20	15	14	12	10								
	-1000	2	6	14	17	13	12	10	8	2	7	17	20	15	14	13	10								
	-750	2	6	14	18	14	13	10	8	2	7	17	20	15	14	13	11								
	0	2	6	14	17	13	13	11	9	2	6	16	20	15	14	13	11								
	+1000	2	6	14	17	13	11	9	8	2	6	16	20	14	12	11	10								
	+1250	2	6	14	17	13	11	9	8	2	6	16	20	14	12	11	10								
42	+1500	2	6	14	17	13	10	9	8	2	6	16	20	14	12	10	10								
	-1000	2	7	13	17	12	11	9	6	3	7	16	19	15	14	11	9								
	-750	2	6	13	16	12	11	9	6	2	7	16	19	15	14	12	9								
	-500	2	6	13	17	13	12	9	7	2	7	16	19	15	14	12	10								
	0	2	6	13	16	12	12	10	9	2	6	15	19	15	14	12	11								
	+750	2	6	13	16	12	10	8	7	2	6	15	19	14	12	10	10								
	+1000	2	6	13	16	12	10	8	7	2	6	15	19	14	11	10	9								
+1100	2	6	13	16	12	9	8	7	2	6	15	19	14	11	9	9									



Straight silencers

SLGU 06

Acoustical Performance – Net Insertion Loss

19

Octave band	1	2	3	4	5	6	7	8	1	2	3	4	5	6	7	8	
Frequency (Hz)	63	125	250	500	1K	2K	4K	8K	63	125	250	500	1K	2K	4K	8K	
Ød ₁ (in)	Velocity (fpm)	Net Insertion Loss (Decibels)								Net Insertion Loss (Decibels)							
L (in)		84								96							
44	-1000	2	7	12	16	11	11	8	5	2	7	15	18	14	13	10	8
	-750	2	6	12	15	11	11	8	5	2	7	15	18	14	14	11	8
	-500	2	6	12	16	12	12	8	6	2	7	15	18	15	14	11	9
	0	2	6	12	15	12	12	9	8	2	6	14	18	15	14	11	10
	+750	2	6	12	15	12	10	7	6	2	6	14	18	14	12	9	9
	+1000	2	6	12	15	11	10	7	6	2	6	14	18	13	11	9	8
	+1100	2	6	12	15	11	9	7	6	2	6	14	18	13	11	9	8
46	-1000	1	6	11	15	11	10	7	5	2	6	13	18	14	13	9	7
	-750	1	5	11	15	11	10	7	5	2	6	14	17	14	13	9	8
	-500	2	5	11	15	11	11	7	6	2	6	14	17	14	13	10	8
	0	2	5	11	14	11	11	8	7	2	6	14	17	14	13	10	9
	+750	1	5	11	14	11	10	7	6	2	5	14	17	13	12	9	9
	+1000	1	5	11	14	11	9	7	6	2	5	13	17	13	11	9	8
	+1100	1	5	11	14	11	8	7	6	1	5	13	17	13	11	8	8
48	-1000	1	6	10	14	10	10	6	4	1	6	12	17	13	12	8	6
	-750	1	5	10	14	10	10	6	4	2	6	13	16	13	13	8	7
	-500	2	5	10	14	10	11	6	5	2	6	13	16	14	13	9	7
	0	2	5	10	13	11	11	7	6	2	6	13	16	14	13	9	8
	+500	1	5	10	13	11	10	6	5	2	5	13	16	13	12	8	8
	+750	1	5	10	13	10	9	6	5	2	5	12	16	12	11	8	7
	+1000	1	5	10	13	10	8	6	5	1	5	12	16	12	11	8	7
50	-1000	1	6	11	15	10	10	7	4	1	6	13	17	13	12	9	7
	-750	1	5	11	14	10	10	7	4	2	6	14	17	13	13	9	7
	-500	2	5	11	15	11	11	7	5	2	6	14	17	14	13	10	8
	0	2	5	11	14	11	11	8	7	2	6	13	17	14	13	10	9
	+500	1	5	11	14	11	10	6	5	2	5	13	17	13	12	8	8
	+750	1	5	11	14	10	9	6	5	2	5	13	17	12	11	8	7
	+1000	1	5	11	14	10	8	6	5	1	5	13	17	12	11	8	7

Notes:

- Net insertion loss, self-generated noise and pressure drop data were obtained through tests conducted by an independent testing laboratory in accordance with ASTM Standard E477-96, entitled "Standard Method of Testing Duct Liner Materials and Prefabricated Silencers for Acoustical and Airflow Performance." Test specimens whose inside diameters correspond to 6", 12", 18", 24", 30", 36", and 42" and whose lengths correspond to the minimum and maximum lengths catalogued were tested and reported. All data presented for other diameters and lengths were interpolated or extrapolated.
- Velocity, indicated as fpm, is determined by dividing the air flow through the silencer (ft³/min) by the cross sectional area of the silencer face (ft²) calculated using the silencer clear inside diameter. Return/exhaust air is indicated as (-) fpm and supply air is indicated as (+) fpm. 0 fpm is the "no flow" condition.
- The pressure drop performance data obtained from ASTM E477-96 "Standard Method of Testing Duct Liner Materials and Prefabricated Silencers for Acoustical and Airflow Performance" are tested at simulated ideal ducted inlet and ducted outlet conditions. Any deviations from these ideal conditions on actual silencer installations should be accounted for in the form of additional pressure loss.
- The self-generated noise for elbow silencers and straight silencers without a baffle is too low to be measured by ASTM E477-96. The measurements obtained for these silencers are equal to or less than the corresponding single wall duct reference condition or within +/- 10dB per ASTM E477-96 section 9.1.2.



Baffle silencers

SLBGU 04



Description

The SLBGU Silencer utilizes a center baffle to provide additional attenuation. It is available with 4" thick insulation.

Dimensions

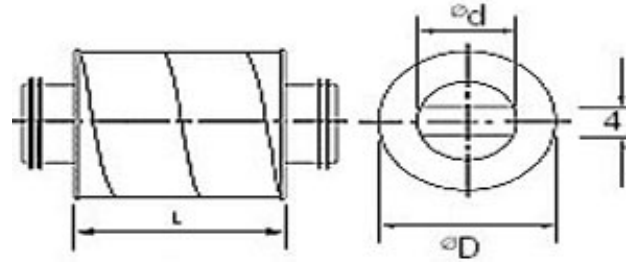

SLBGU 04: $\text{Ø}d_y = \text{Ø}d_1 + 8$

20

Ordering example

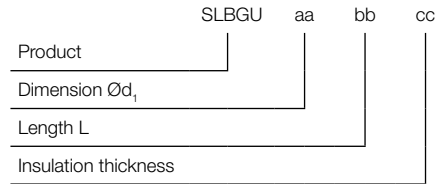

Baffle silencers

SLBGU 04

Acoustical Performance – Net Insertion Loss

21

Octave band	1	2	3	4	5	6	7	8	1	2	3	4	5	6	7	8	1	2	3	4	5	6	7	8	
Frequency (Hz)	63	125	250	500	1K	2K	4K	8K	63	125	250	500	1K	2K	4K	8K	63	125	250	500	1K	2K	4K	8K	
Ød ₁ (in)	Net Insertion Loss (Decibels)								Net Insertion Loss (Decibels)								Net Insertion Loss (Decibels)								
Velocity (fpm)	Net Insertion Loss (Decibels)								Net Insertion Loss (Decibels)								Net Insertion Loss (Decibels)								
L (in)	24								36								48								
12	-6000	2	6	14	18	27	26	20	15	2	11	21	29	37	36	30	20	2	15	28	39	47	46	39	24
	-4000	2	6	13	17	26	26	21	15	2	11	20	28	37	36	31	22	1	14	27	38	47	46	39	26
	-2000	2	6	13	17	26	26	21	16	0	10	19	26	36	37	31	24	0	13	26	36	46	46	40	28
	0	0	5	11	16	24	27	21	18	0	9	17	25	35	37	31	25	0	12	22	34	45	47	41	31
	+2000	0	5	11	15	23	26	20	18	0	8	16	24	34	37	31	25	0	10	20	32	44	47	40	31
	+4000	0	5	10	14	23	26	20	18	0	8	15	23	33	36	30	25	0	10	19	31	43	46	40	32
	+6000	0	5	10	14	22	25	20	17	0	7	14	22	32	35	30	25	0	9	18	30	41	45	40	32
14	-6000	2	6	12	17	24	24	19	15	2	10	19	26	34	33	27	19	3	13	26	35	44	42	35	22
	-4000	2	7	11	16	24	24	21	16	2	10	18	25	34	33	28	20	2	12	25	34	44	42	35	24
	-2000	0	6	10	15	23	25	20	18	1	9	17	24	33	34	28	21	1	12	24	33	43	42	35	25
	0	0	5	10	14	22	24	19	17	1	8	15	23	32	34	28	22	1	11	21	31	42	43	36	27
	+2000	0	5	10	14	21	24	18	15	1	7	14	21	31	34	28	22	1	9	19	29	41	43	38	29
	+4000	0	5	9	13	21	24	19	16	0	7	14	21	30	33	27	22	1	9	18	28	40	42	35	28
	+6000	0	4	9	12	21	24	19	16	0	6	13	20	30	32	27	22	1	8	17	27	38	41	35	28
16	L (in)	36								48								60							
	-4000	3	8	17	23	31	30	24	17	3	12	23	32	40	38	30	21	4	15	30	40	50	46	37	24
	-3000	2	8	16	22	31	30	24	18	2	11	22	31	40	38	30	21	3	13	29	39	50	46	36	25
	-2000	1	7	15	21	30	30	24	19	2	10	21	29	39	38	31	22	3	13	28	37	49	46	37	25
	0	1	6	14	20	29	30	24	19	2	9	19	28	38	39	31	24	3	12	25	36	48	48	38	28
	+2000	1	6	13	19	28	30	25	19	2	8	18	26	37	39	37	28	3	10	23	33	47	48	48	36
	+3000	1	6	12	18	28	30	25	19	1	8	17	25	36	38	31	24	2	10	22	32	45	46	37	29
+4000	1	6	12	17	27	30	25	19	1	8	17	24	35	37	31	24	2	10	21	31	43	44	37	29	
18	-4000	3	7	15	20	28	27	21	16	4	10	21	28	37	34	26	19	5	12	28	35	45	41	30	22
	-3000	2	7	14	19	28	27	21	16	3	9	20	27	37	34	26	19	4	11	27	34	45	41	30	22
	-2000	2	6	13	19	27	27	21	16	3	9	19	26	36	34	26	19	4	11	26	33	45	41	30	23
	0	2	5	12	18	26	27	21	16	3	8	18	25	35	35	26	20	4	10	24	32	44	42	30	23
	+2000	2	5	11	16	25	27	22	16	3	7	17	23	34	35	35	26	3	9	22	29	41	42	29	23
	+3000	1	5	11	16	25	27	22	16	2	7	16	22	33	34	26	20	3	8	21	28	40	40	29	23
	+4000	1	5	11	15	25	27	22	16	2	7	16	21	32	33	26	20	3	8	20	27	39	39	29	23
20	-4000	3	7	14	18	26	25	20	15	4	9	19	26	34	32	24	18	5	12	24	33	42	38	28	21
	-3000	2	6	13	18	26	25	20	15	3	8	18	25	34	32	24	18	4	10	23	32	42	38	28	21
	-2000	2	6	12	18	25	25	20	15	3	8	18	24	33	32	24	18	4	11	23	30	41	38	28	21
	0	2	5	11	17	24	25	20	15	3	7	16	23	32	32	24	19	4	10	22	29	40	39	28	23
	+2000	2	5	10	15	23	25	20	15	3	7	16	22	31	32	30	23	3	9	21	28	39	39	40	31
	+3000	1	5	10	15	23	25	20	15	2	7	15	21	30	31	24	18	3	9	19	27	37	38	27	22
	+4000	1	5	10	14	23	25	20	15	2	7	15	20	30	30	23	18	3	9	19	26	36	36	27	22



Baffle silencers

SLBGU 04

Acoustical Performance – Net Insertion Loss

Octave band	1	2	3	4	5	6	7	8	1	2	3	4	5	6	7	8	1	2	3	4	5	6	7	8	
Frequency (Hz)	63	125	250	500	1K	2K	4K	8K	63	125	250	500	1K	2K	4K	8K	63	125	250	500	1K	2K	4K	8K	
Ød ₁ (in)	Velocity (fpm)	Net Insertion Loss (Decibels)								Net Insertion Loss (Decibels)								Net Insertion Loss (Decibels)							
L (in)		36								48								60							
22	-4000	3	6	12	17	23	24	18	15	4	9	17	23	30	29	22	18	5	11	22	30	37	35	26	21
	-3000	3	6	11	16	23	24	18	15	3	8	16	22	30	29	22	18	3	10	21	28	37	35	26	21
	-2000	2	5	12	16	23	24	18	15	3	8	16	22	30	29	22	18	4	10	21	28	37	35	26	21
	0	2	4	10	15	22	24	18	15	3	7	15	21	29	30	22	18	4	9	19	27	36	36	26	21
	+2000	2	4	10	15	22	23	19	15	2	6	14	20	28	29	25	20	3	8	19	26	34	35	31	25
	+3000	2	4	10	13	22	23	18	14	2	6	13	19	28	29	21	17	2	8	17	25	34	34	25	19
	+4000	2	4	10	14	22	22	18	14	2	6	13	19	27	28	21	17	2	8	17	24	33	33	23	19
24	-2000	3	6	11	15	21	22	17	14	4	8	15	21	27	27	20	17	5	10	20	27	34	32	23	20
	-1500	3	5	10	15	21	22	17	14	3	7	14	20	27	27	20	17	4	9	19	26	33	32	23	20
	-1000	2	5	11	15	21	22	17	14	3	7	15	20	27	27	20	17	4	9	19	26	33	32	23	20
	0	2	4	9	14	20	22	17	14	3	6	13	19	26	27	20	17	4	8	17	24	32	32	23	21
	+1000	2	4	9	14	20	21	17	14	2	6	13	19	25	26	20	17	3	8	17	24	31	31	23	20
	+2000	2	4	9	12	20	21	16	13	2	6	12	18	25	26	19	15	3	8	16	23	31	31	22	18
	+3000	2	4	9	13	20	20	16	13	2	6	12	18	25	25	18	15	3	8	16	22	31	30	21	18
26	L (in)	48								60								72							
	-2000	3	8	14	20	25	25	19	16	4	9	19	25	31	29	22	19	5	11	23	31	37	33	24	22
	-1500	3	7	14	19	25	25	19	16	3	9	18	25	31	29	22	19	4	10	22	30	36	33	24	22
	-1000	3	7	14	19	25	25	19	16	3	9	18	25	31	29	22	19	4	10	22	30	36	33	24	22
	0	3	6	13	18	25	25	19	16	3	8	16	23	30	29	22	20	4	9	19	28	35	33	24	23
	+1000	2	6	13	18	24	24	19	16	3	8	16	23	29	28	21	19	3	9	20	28	35	33	24	22
	+2000	2	6	12	18	24	24	18	15	3	8	16	22	29	28	21	17	3	9	20	27	35	32	23	20
+3000	2	6	12	18	24	23	18	15	3	8	16	22	29	28	20	17	3	9	20	26	35	32	22	20	
28	-2000	2	7	12	17	22	21	17	15	3	8	16	22	26	24	19	17	3	9	19	26	31	28	22	19
	-1500	2	6	12	17	22	21	17	15	2	8	15	21	26	24	19	17	2	9	19	26	31	28	22	19
	-1000	2	6	12	17	22	21	17	15	2	8	16	21	26	24	19	17	3	9	19	26	31	28	22	19
	0	2	6	11	16	21	21	17	15	2	7	14	20	26	24	19	17	3	7	16	25	31	28	22	19
	+1000	2	6	11	16	21	20	17	15	2	7	14	20	26	24	19	17	2	7	18	25	30	28	20	19
	+2000	2	5	10	15	21	20	17	14	2	7	14	20	26	23	18	16	2	8	18	25	31	26	20	17
	+3000	3	5	10	16	21	20	17	14	2	7	14	20	26	24	18	16	1	8	18	24	31	27	19	17
30	-1750	2	7	13	18	22	20	17	15	2	8	16	22	26	23	19	17	3	9	20	27	31	26	21	19
	-1500	2	7	13	18	22	20	17	15	2	8	16	22	26	23	19	17	3	9	20	26	31	26	21	19
	-1000	2	7	13	18	22	20	17	15	2	8	16	22	26	23	19	17	2	9	20	26	31	26	21	19
	0	2	7	12	17	22	20	17	15	2	7	14	21	26	23	19	17	2	8	19	25	31	26	21	19
	+1000	2	7	12	17	22	20	17	15	2	7	15	21	26	23	18	17	3	8	18	25	31	26	20	19
	+1500	2	6	11	17	21	20	17	15	2	7	15	21	26	22	18	16	3	8	18	25	31	25	20	18
	+2000	3	6	11	17	21	20	17	15	2	7	15	21	26	23	18	16	2	8	18	25	31	25	20	18



Baffle silencers

SLBGU 04

Acoustical Performance – Net Insertion Loss

23

Octave band	1	2	3	4	5	6	7	8	1	2	3	4	5	6	7	8	1	2	3	4	5	6	7	8	
Frequency (Hz)	63	125	250	500	1K	2K	4K	8K	63	125	250	500	1K	2K	4K	8K	63	125	250	500	1K	2K	4K	8K	
Ød ₁ (in)	Net Insertion Loss (Decibels)								Net Insertion Loss (Decibels)								Net Insertion Loss (Decibels)								
Velocity (fpm)	Net Insertion Loss (Decibels)								Net Insertion Loss (Decibels)								Net Insertion Loss (Decibels)								
L (in)	60								72								84								
32	-1750	2	7	16	21	25	21	18	16	2	8	19	26	29	23	19	17	3	9	23	30	33	26	21	19
	-1500	2	7	16	21	25	21	18	16	2	8	19	25	29	23	19	17	3	9	22	29	33	26	21	19
	-1000	2	7	16	21	25	21	18	16	2	8	19	25	29	23	19	17	2	9	22	29	33	26	21	19
	0	2	7	14	20	25	21	18	16	2	7	18	24	29	23	19	17	2	8	23	28	33	26	21	19
	+1000	2	7	15	20	25	21	17	15	2	7	17	24	29	23	18	17	3	8	20	28	33	25	20	19
	+1500	2	6	15	20	25	20	17	15	2	7	17	24	29	22	18	17	3	8	20	28	33	25	20	19
	+2000	2	7	15	20	25	21	17	15	2	7	17	24	29	22	18	17	2	8	20	28	34	24	20	19
34	-1750	1	7	15	21	24	19	16	14	2	8	19	24	27	21	18	16	2	9	22	28	30	22	19	17
	-1500	1	7	15	21	24	19	16	14	2	7	18	24	27	21	18	16	2	7	21	27	30	22	19	17
	-1000	1	7	15	21	24	19	16	14	1	7	18	24	27	21	18	16	1	7	21	27	30	22	19	17
	0	1	6	14	20	25	18	16	14	1	7	18	23	28	21	18	16	1	7	21	26	31	23	19	17
	+1000	1	6	14	20	23	18	15	14	2	7	17	23	27	20	17	16	2	7	19	26	31	22	18	18
	+1500	1	6	14	20	23	18	15	13	2	7	17	23	27	20	17	15	2	8	19	26	31	21	18	17
	+2000	1	6	14	20	23	18	15	13	1	7	17	23	28	20	17	15	1	7	19	26	32	21	18	17
36	-1250	1	6	15	20	23	17	15	13	1	7	18	23	25	18	16	14	1	8	21	26	28	20	17	16
	-1000	1	6	15	20	23	17	15	13	1	6	17	23	25	18	16	14	1	7	20	26	28	20	17	16
	-750	1	6	15	20	23	17	15	13	1	6	17	23	25	18	16	14	1	7	20	25	28	20	18	16
	0	1	6	14	19	24	16	15	13	1	6	17	22	26	18	16	14	1	7	20	25	28	20	17	15
	+1000	1	6	14	19	22	16	14	12	1	6	16	22	25	17	15	14	1	7	19	25	29	19	16	14
	+1250	1	5	14	19	22	16	14	12	1	6	16	22	25	17	15	14	1	7	19	25	29	19	16	15
	+1500	1	6	14	19	22	16	14	12	1	6	16	22	26	17	15	14	1	7	19	25	30	19	16	15
38	L (in)	72								84								96							
	-1250	2	7	17	22	23	17	15	13	2	7	19	25	26	19	15	14	2	8	22	28	29	21	16	16
	-1000	2	6	16	22	23	17	15	13	2	7	19	25	27	19	16	14	2	7	21	28	30	21	17	16
	-750	1	6	16	22	23	17	15	13	2	7	19	24	27	19	16	14	2	8	21	26	30	21	18	16
	0	2	6	16	21	25	18	15	13	2	7	19	24	27	19	16	15	2	7	21	27	29	21	17	17
	+1000	2	6	15	21	24	17	14	13	2	7	18	24	28	18	15	14	2	8	21	27	31	19	15	15
	+1250	2	6	15	21	24	16	14	13	2	7	18	24	27	18	15	14	2	7	21	27	30	19	16	14
+1500	2	6	15	21	25	16	14	13	2	7	18	24	28	18	15	14	2	7	21	27	31	19	16	15	
40	-1250	2	6	15	21	22	16	13	11	2	7	18	24	25	18	14	13	2	7	20	27	28	20	14	14
	-1000	2	6	15	21	22	16	13	11	2	6	17	24	25	18	14	13	2	7	20	27	29	20	15	14
	-750	2	6	15	21	22	17	13	11	2	7	17	23	25	18	15	13	3	8	20	25	29	19	16	14
	0	2	6	15	21	24	17	15	11	2	6	17	23	26	19	16	14	2	7	20	25	28	20	17	17
	+1000	2	6	15	21	24	16	13	12	2	7	17	23	26	17	13	14	2	8	19	25	29	18	14	16
	+1250	2	6	15	21	24	16	12	12	2	6	17	23	26	16	13	12	2	7	19	25	28	17	14	13
	+1500	2	6	15	21	24	16	12	11	2	6	17	23	26	16	13	12	2	7	19	25	28	17	14	13



Baffle silencers

SLBGU 04

Acoustical Performance – Net Insertion Loss

Octave band	1	2	3	4	5	6	7	8	1	2	3	4	5	6	7	8	1	2	3	4	5	6	7	8	
Frequency (Hz)	63	125	250	500	1K	2K	4K	8K	63	125	250	500	1K	2K	4K	8K	63	125	250	500	1K	2K	4K	8K	
Ød ₁ (in)	Velocity (fpm)	Net Insertion Loss (Decibels)								Net Insertion Loss (Decibels)								Net Insertion Loss (Decibels)							
L (in)		72								84								96							
42	-1000	3	6	14	20	20	15	12	10	3	6	16	23	23	17	12	11	2	7	19	26	27	19	15	11
	-750	3	6	14	20	20	15	12	10	3	6	16	23	24	17	13	11	3	7	19	26	28	19	15	12
	-500	2	6	14	20	20	16	12	10	3	7	16	22	24	17	13	11	3	8	19	25	28	19	15	12
	0	3	6	14	20	23	17	14	10	3	6	16	22	25	18	15	14	2	7	18	25	28	19	16	15
	+750	3	6	14	20	23	16	12	11	3	7	16	22	25	16	12	14	2	8	18	25	27	17	13	12
	+1000	3	6	14	20	23	15	11	11	3	6	16	22	24	15	12	11	2	7	18	25	26	16	13	11
	+1100	3	6	14	20	23	15	11	10	3	6	16	22	24	15	12	11	3	7	18	25	26	16	13	12
L (in)		84								96															
44	-1000	3	6	14	22	22	16	11	10	2	7	18	25	25	18	14	11								
	-750	3	6	14	22	23	15	12	10	3	7	18	25	26	18	14	11								
	-500	3	6	14	21	23	15	12	10	3	7	17	24	26	17	14	11								
	0	3	6	14	21	24	16	13	12	2	7	17	24	26	17	14	13								
	+750	3	6	14	21	23	15	11	12	2	7	17	24	25	16	12	11								
	+1000	3	5	14	21	23	14	11	10	2	6	17	24	25	15	12	10								
	+1100	3	5	14	21	23	14	11	10	3	6	16	24	25	15	12	11								
46	-1000	2	5	13	20	20	14	11	9	3	6	16	23	24	16	13	10								
	-750	2	5	13	20	21	14	11	9	2	6	16	23	25	16	13	10								
	-500	2	6	13	21	21	14	11	8	2	6	16	23	25	16	12	9								
	0	3	5	12	20	22	14	11	9	3	6	16	22	25	16	13	10								
	+750	2	5	12	19	22	13	10	9	2	7	15	22	24	14	11	9								
	+1000	2	5	12	19	22	12	10	8	2	6	15	22	23	14	11	9								
	+1100	2	5	12	19	21	12	10	8	3	6	15	22	23	14	11	9								
48	-1000	2	5	11	19	19	13	10	8	3	6	15	22	22	15	12	10								
	-750	2	5	11	19	20	12	10	8	2	6	15	22	23	15	12	9								
	-500	2	5	11	20	20	12	10	7	2	5	14	22	23	14	11	8								
	0	3	5	10	19	21	12	9	7	3	6	15	21	23	14	11	8								
	+500	2	4	10	18	20	12	9	7	2	6	14	21	22	13	10	8								
	+750	2	4	10	18	21	11	9	7	2	5	14	21	22	13	10	8								
	+1000	2	4	10	18	20	11	9	7	3	5	13	21	22	13	10	8								
50	-1000	2	5	9	18	18	12	9	7	3	6	14	21	20	14	11	10								
	-750	2	5	9	18	19	10	9	7	2	6	14	21	21	14	11	8								
	-500	2	4	9	19	19	10	9	6	2	4	12	21	21	12	10	7								
	0	3	5	8	18	20	10	7	5	3	6	14	20	21	12	9	6								
	+500	2	3	8	17	18	11	8	5	2	5	13	20	20	12	9	7								
	+750	2	3	8	17	20	10	8	6	2	4	13	20	21	12	9	7								
	+1000	2	3	8	17	19	10	8	6	3	4	11	20	21	12	9	7								



Acoustical Performance – Net Insertion Loss

25

Notes:

1. Net insertion loss, self-generated noise and pressure drop data were obtained through tests conducted by an independent testing laboratory in accordance with ASTM Standard E477-96, entitled "Standard Method of Testing Duct Liner Materials and Prefabricated Silencers for Acoustical and Airflow Performance." Test specimens whose inside diameters correspond to 6", 12", 18", 24", 30", 36", and 42" and whose lengths correspond to the minimum and maximum lengths catalogued were tested and reported. All data presented for other diameters and lengths were interpolated or extrapolated.
2. Velocity, indicated as fpm, is determined by dividing the air flow through the silencer (ft^3/min) by the cross sectional area of the silencer face (ft^2) calculated using the silencer clear inside diameter. Return/exhaust air is indicated as (-) fpm and supply air is indicated as (+) fpm. 0 fpm is the "no flow" condition.
3. The pressure drop performance data obtained from ASTM E477-96 "Standard Method of Testing Duct Liner Materials and Prefabricated Silencers for Acoustical and Airflow Performance" are tested at simulated ideal ducted inlet and ducted outlet conditions. Any deviations from these ideal conditions on actual silencer installations should be accounted for in the form of additional pressure loss.
4. The self-generated noise for elbow silencers and straight silencers without a baffle is too low to be measured by ASTM E477-96. The measurements obtained for these silencers are equal to or less than the corresponding single wall duct reference condition or within +/- 10dB per ASTM E477-96 section 9.1.2.

Baffle silencers

SLBGU 04

Acoustical Performance – Self generated noise

Octave band	1	2	3	4	5	6	7	8	1	2	3	4	5	6	7	8	1	2	3	4	5	6	7	8		
Frequency (Hz)	63	125	250	500	1K	2K	4K	8K	63	125	250	500	1K	2K	4K	8K	63	125	250	500	1K	2K	4K	8K		
Ød ₁ (in)	Net Insertion Loss (Decibels)								Net Insertion Loss (Decibels)								Net Insertion Loss (Decibels)									
L (in)	24								36								48									
12	-6000	72	71	63	57	57	59	62	61	72	70	62	58	58	59	62	60	71	69	60	59	58	59	62	59	
	-4000	67	66	55	50	51	54	58	50	67	64	55	52	52	54	57	52	67	62	54	53	52	54	56	53	
	-2000	62	57	46	41	43	47	46	33	62	55	46	43	44	47	47	36	62	52	46	44	45	47	47	38	
	+2000	62	61	52	47	47	45	40	31	64	59	51	48	49	47	42	33	65	57	50	48	50	49	44	34	
	+4000	69	69	63	56	56	56	54	54	68	68	61	56	57	58	56	52	67	66	59	56	58	59	57	50	
	+6000	75	74	69	63	63	62	62	56	74	73	68	63	64	64	64	59	72	72	67	62	64	65	65	61	
14	-6000	75	71	63	57	58	60	62	61	74	70	61	58	58	60	62	61	73	69	60	59	58	60	63	61	
	-4000	70	65	55	51	52	55	57	51	69	64	54	52	52	55	57	53	69	62	54	53	52	55	58	55	
	-2000	64	56	46	42	44	48	47	32	64	54	45	43	45	48	48	35	64	52	45	44	45	49	49	38	
	+2000	64	59	49	46	46	45	39	31	64	57	49	46	47	46	40	32	65	55	48	47	48	47	42	33	
	+4000	70	68	60	55	55	56	54	52	69	67	59	55	56	57	54	50	68	65	57	55	57	58	55	49	
	+6000	77	74	67	61	62	62	62	56	76	73	66	61	62	63	63	58	74	71	65	61	63	64	64	59	
16	L (in)	36								48								60								
		-4000	77	70	61	58	59	60	63	62	76	69	60	58	58	61	64	64	75	67	58	59	58	61	65	65
		-3000	72	63	54	52	53	55	58	54	71	62	53	52	53	56	59	56	70	61	53	52	53	56	61	59
		-2000	65	54	45	44	45	49	49	35	65	51	44	44	46	50	51	39	65	49	44	44	46	51	53	42
		+2000	65	55	46	45	46	44	39	31	65	53	46	45	47	45	39	31	66	52	46	46	47	45	40	32
		+3000	71	66	56	53	55	56	53	48	70	64	55	54	55	56	53	47	69	62	54	54	56	56	54	46
+4000	78	72	64	60	61	62	62	57	76	71	63	60	61	62	62	58	74	69	62	60	62	63	63	59		
18	-4000	79	70	61	58	59	61	63	63	78	69	60	58	59	62	65	66	77	67	58	58	58	62	67	69	
	-3000	74	63	53	52	53	56	58	55	73	62	53	52	53	57	61	58	72	61	52	51	53	57	64	61	
	-2000	67	53	44	44	46	50	50	35	67	51	44	44	46	52	53	39	67	49	43	43	46	53	55	43	
	+2000	66	53	44	43	45	43	37	30	66	52	44	44	45	43	37	30	65	50	44	44	45	42	37	30	
	+3000	72	65	54	52	54	55	52	46	71	63	54	53	54	55	52	46	70	61	53	53	54	54	51	45	
	+4000	80	72	62	58	59	61	61	56	78	70	61	59	60	61	61	56	76	68	60	59	60	61	61	56	
20	-4000	77	67	59	56	57	58	60	56	77	66	58	56	56	59	63	59	76	65	57	56	56	60	65	62	
	-3000	72	61	52	50	50	53	51	48	72	60	51	50	50	54	55	50	71	59	50	49	50	56	58	52	
	-2000	65	52	43	41	43	43	41	33	66	50	42	41	44	46	44	36	66	49	42	41	44	49	46	38	
	+2000	64	51	40	38	38	35	33	30	64	50	40	38	37	35	33	30	63	50	41	39	37	34	33	30	
	+3000	70	64	52	50	51	51	47	40	69	62	52	50	51	50	46	40	69	60	52	51	51	50	46	40	
	+4000	78	71	60	57	58	59	58	53	77	69	60	57	58	59	58	52	75	67	59	58	58	59	58	52	
22	-4000	76	65	58	55	54	56	56	48	75	64	57	54	54	57	60	51	75	63	56	54	53	58	64	54	
	-3000	71	58	50	48	48	49	45	40	70	57	50	48	48	52	48	42	69	56	49	47	48	54	51	44	
	-2000	64	50	41	39	40	35	33	31	64	49	41	39	41	40	35	32	65	48	40	38	42	44	37	34	
	+2000	63	49	36	33	30	27	28	29	62	49	37	33	30	27	29	29	60	49	37	33	29	26	30	29	
	+3000	67	62	50	47	49	46	42	35	67	61	50	48	48	46	41	35	67	60	50	49	48	45	40	36	
	+4000	77	70	58	55	56	57	56	49	76	68	58	56	57	57	55	49	75	67	58	57	57	56	54	48	
24	-2000	74	62	56	53	52	53	53	41	74	62	56	53	52	55	58	44	74	61	55	52	51	56	62	47	
	-1500	69	56	49	46	45	46	38	33	69	55	48	46	45	50	42	34	68	54	47	45	45	53	45	35	
	-1000	62	49	40	36	37	28	24	29	63	49	40	36	39	34	26	29	64	48	39	36	40	40	28	29	
	+1000	61	47	32	28	23	19	24	29	60	48	33	28	22	19	25	29	58	49	34	28	21	18	26	29	
	+2000	65	61	48	45	46	42	37	29	66	60	49	46	46	42	36	30	66	59	49	47	45	41	35	31	
	+3000	75	69	56	54	55	55	53	46	75	68	57	55	55	55	52	45	74	66	57	56	55	54	51	44	
L (in)	48								60								72									



Baffle silencers

SLBGU 04

Acoustical Performance – Self generated noise

27

Octave band	1	2	3	4	5	6	7	8	1	2	3	4	5	6	7	8	1	2	3	4	5	6	7	8	
Frequency (Hz)	63	125	250	500	1K	2K	4K	8K	63	125	250	500	1K	2K	4K	8K	63	125	250	500	1K	2K	4K	8K	
Ød ₁ (in)	Velocity (fpm)	Net Insertion Loss (Decibels)								Net Insertion Loss (Decibels)								Net Insertion Loss (Decibels)							
26	-2000	76	63	57	53	52	55	56	42	76	63	56	53	52	56	59	44	76	62	56	53	52	57	62	46
	-1500	72	58	51	48	47	50	43	34	72	57	50	48	47	53	46	35	71	57	49	47	47	55	48	36
	-1000	65	50	42	38	39	34	27	30	66	50	41	38	40	38	29	30	67	49	40	38	41	42	30	30
	+1000	61	48	34	31	24	21	26	30	60	49	35	31	24	21	27	30	59	49	36	31	23	21	28	30
	+2000	68	60	48	45	44	39	35	31	69	59	48	46	44	38	34	32	69	58	49	47	43	38	33	33
	+3000	76	67	56	53	53	51	48	41	76	65	56	54	53	51	48	41	75	64	56	55	53	51	47	40
28	-2000	78	65	58	54	53	56	54	40	78	64	58	54	53	56	56	41	78	64	58	54	53	56	58	43
	-1500	76	61	53	50	50	51	45	34	75	61	53	50	50	52	46	35	75	60	53	50	50	54	48	35
	-1000	68	52	44	39	40	35	28	31	68	52	43	39	40	36	29	31	68	51	42	39	41	38	30	31
	+1000	63	48	36	33	27	23	27	30	63	48	36	33	27	23	28	31	62	48	36	33	27	24	28	31
	+2000	71	60	48	44	42	36	33	32	71	59	48	45	42	36	33	33	72	59	48	45	42	36	33	33
	+3000	78	66	56	52	51	48	45	38	78	65	55	52	51	48	44	37	77	64	55	52	51	48	43	36
30	-1750	80	66	59	55	53	56	52	38	80	66	59	55	54	56	53	39	80	66	59	55	54	55	53	39
	-1500	79	64	56	52	52	52	46	34	79	64	56	53	52	52	47	35	78	64	56	53	52	52	47	35
	-1000	70	54	46	41	41	35	29	32	70	54	45	41	41	35	30	32	70	53	44	41	40	34	30	32
	+1000	65	48	37	36	29	25	28	31	65	48	37	36	30	26	29	32	65	47	37	36	30	27	29	32
	+1500	74	60	47	43	40	33	32	33	74	60	47	44	41	33	32	34	74	59	47	44	41	33	32	34
	+2000	80	65	55	50	49	45	41	34	80	64	54	50	49	45	41	34	79	63	53	50	49	45	40	33
L (in)	60								72								84								
32	-1750	78	63	54	50	47	47	44	35	78	63	54	50	47	47	44	36	78	62	54	50	48	46	45	36
	-1500	75	61	50	44	42	41	39	32	75	60	50	45	42	41	39	33	75	59	50	45	42	41	39	33
	-1000	68	51	41	34	33	29	27	31	68	50	40	34	32	29	28	31	68	50	39	34	32	28	28	31
	+1000	67	51	38	36	29	26	28	31	68	51	39	36	30	27	29	31	68	51	39	37	31	27	29	32
	+1500	74	60	47	43	40	33	33	32	75	60	47	44	41	34	33	33	75	59	48	44	41	34	33	34
	+2000	80	66	54	49	47	43	40	34	80	65	53	49	48	44	40	34	79	64	52	50	48	44	40	34
34	-1750	75	59	50	44	41	39	36	32	76	59	50	44	41	38	36	32	76	59	50	44	41	38	36	33
	-1500	72	57	43	36	32	30	31	30	72	56	44	36	32	30	31	30	73	55	44	37	32	30	31	31
	-1000	66	48	38	27	25	24	25	29	66	47	36	27	25	23	25	29	66	47	35	28	25	23	26	29
	+1000	70	55	40	35	29	26	28	30	70	55	40	36	30	26	28	30	71	55	41	37	32	27	29	31
	+1500	75	61	47	43	39	34	33	31	76	60	48	43	40	34	33	32	77	60	48	44	41	34	33	33
	+2000	80	67	54	48	46	42	40	34	80	66	53	49	47	42	40	35	80	65	53	49	48	43	40	36
36	-1250	73	56	45	39	34	30	27	29	74	56	45	39	34	30	27	29	74	55	45	39	34	29	27	29
	-1000	69	54	37	28	22	19	23	28	70	52	38	28	22	19	23	28	70	50	38	28	22	19	23	28
	-750	64	45	34	20	17	18	23	28	64	45	33	21	17	18	23	28	64	44	31	21	17	18	23	28
	+1000	72	58	41	35	29	26	27	29	73	59	42	37	31	26	28	30	74	59	43	38	32	26	29	30
	+1250	75	61	47	42	38	34	34	30	77	61	48	43	40	35	34	31	78	61	49	44	41	35	34	32
	+1500	80	69	54	47	44	40	39	34	81	68	54	48	46	41	40	36	81	67	53	49	47	42	40	37
L (in)	72								84								96								
38	-1250	74	57	47	41	36	31	29	31	74	57	47	41	36	31	29	31	74	56	46	41	37	30	29	31
	-1000	70	52	39	31	24	19	23	28	70	51	39	31	24	19	23	29	70	49	39	30	25	19	23	29
	-750	65	44	33	22	18	19	23	28	65	44	32	22	18	18	23	28	64	44	30	23	18	18	23	28
	+1000	72	59	43	37	31	28	29	30	73	59	43	38	32	27	29	30	74	58	43	39	32	26	29	30
	+1250	76	63	49	44	40	36	35	32	77	62	49	44	41	36	35	33	78	62	49	45	41	35	35	33
	+1500	79	68	55	48	45	41	40	37	80	67	54	49	46	42	40	38	80	66	54	49	47	42	40	38
L (in)	72								84								96								



Baffle silencers

SLBGU 04

Acoustical Performance – Self generated noise

Octave band	1	2	3	4	5	6	7	8	1	2	3	4	5	6	7	8	1	2	3	4	5	6	7	8	
Frequency (Hz)	63	125	250	500	1K	2K	4K	8K	63	125	250	500	1K	2K	4K	8K	63	125	250	500	1K	2K	4K	8K	
Ød ₁ (in)	Velocity (fpm)	Net Insertion Loss (Decibels)								Net Insertion Loss (Decibels)								Net Insertion Loss (Decibels)							
		40	-1250	75	58	48	43	38	32	31	34	74	58	48	43	39	32	31	33	74	58	48	43	39	32
-1000	70		51	40	34	26	20	23	29	70	51	40	33	27	20	23	29	70	51	40	32	27	20	23	29
-750	66		44	34	24	18	19	23	28	65	44	32	24	18	19	23	28	64	45	31	24	18	18	23	28
+1000	71		59	43	37	31	29	30	30	72	58	43	37	31	28	29	30	72	57	43	38	31	27	29	30
+1250	76		64	50	44	40	37	37	34	76	64	49	45	40	36	36	33	77	63	49	45	40	35	35	32
+1500	78		68	56	49	45	42	41	39	78	67	55	49	45	41	41	39	78	66	55	49	46	40	40	38
42	-1000	75	59	50	45	40	33	33	36	75	60	50	45	41	34	33	36	74	60	49	45	42	34	33	35
	-750	70	51	41	37	28	20	23	29	70	52	41	36	29	20	23	30	70	52	41	34	30	20	23	30
	-500	67	44	34	25	19	20	23	28	66	45	33	25	19	19	23	28	64	45	31	25	19	18	23	28
	+750	70	59	44	37	31	31	31	30	71	58	43	37	31	29	30	30	71	56	42	37	30	27	28	30
	+1000	75	66	51	45	40	38	38	35	76	65	50	45	40	37	37	34	76	64	48	45	39	35	36	32
	+1100	77	68	57	49	45	42	42	41	77	67	57	49	45	41	41	40	76	66	56	48	44	39	40	38
L (in)	84								96																
44	-1000	73	58	48	44	40	32	32	34	73	59	48	44	41	33	32	34								
	-750	69	50	40	34	28	19	22	28	69	51	40	33	29	19	22	29								
	-500	64	43	31	24	18	18	22	27	63	44	30	24	18	17	22	27								
	+750	69	56	42	36	29	28	28	29	70	55	41	36	29	26	27	29								
	+1000	74	64	48	44	38	35	36	32	75	63	47	44	38	34	35	31								
	+1100	75	66	55	47	43	39	40	38	75	65	55	47	43	38	39	37								
46	-1000	72	57	47	42	38	31	30	33	71	57	46	42	39	31	30	32								
	-750	67	49	38	33	26	17	20	27	67	49	38	31	27	17	20	27								
	-500	63	42	30	22	16	16	20	25	61	42	28	22	16	15	20	25								
	+750	68	55	40	34	28	26	27	27	68	53	39	34	27	24	25	27								
	+1000	73	62	47	42	37	34	34	31	73	61	45	42	36	32	33	29								
	+1100	74	64	54	46	42	38	38	37	73	63	53	45	41	36	37	35								
48	-1000	70	55	45	41	37	29	29	31	70	56	45	41	38	30	29	31								
	-750	66	47	37	31	25	16	19	25	66	48	37	30	26	16	19	26								
	-500	61	40	28	21	15	15	19	24	60	41	27	21	15	14	19	24								
	+500	66	53	39	33	26	25	25	26	67	52	38	33	26	23	24	26								
	+750	71	61	45	41	35	32	33	29	72	60	44	41	35	31	32	28								
	+1000	72	63	52	44	40	36	37	35	72	62	52	44	40	35	36	34								
50	-1000	69	54	44	39	35	28	27	30	68	54	43	39	36	28	27	29								
	-750	64	46	35	30	23	14	17	24	64	46	35	28	24	14	17	24								
	-500	60	39	27	19	13	13	17	22	58	39	25	19	13	12	17	22								
	+500	65	52	37	31	25	23	24	24	65	50	36	31	24	21	22	24								
	+750	70	59	44	39	34	31	31	28	70	58	42	39	33	29	30	26								
	+1000	71	61	51	43	39	35	35	34	70	60	50	42	38	33	34	32								

Notes:

- Net insertion loss, self-generated noise and pressure drop data were obtained through tests conducted by an independent testing laboratory in accordance with ASTM Standard E477-96, entitled "Standard Method of Testing Duct Liner Materials and Prefabricated Silencers for Acoustical and Airflow Performance." Test specimens whose inside diameters correspond to 6", 12", 18", 24", 30", 36", and 42" and whose lengths correspond to the minimum and maximum lengths catalogued were tested and reported. All data presented for other diameters and lengths were interpolated or extrapolated.
- Velocity, indicated as fpm, is determined by dividing the air flow through the silencer (ft³/min) by the cross sectional area of the silencer face (ft²) calculated using the silencer clear inside diameter. Return/exhaust air is indicated as (-) fpm and supply air is indicated as (+) fpm. 0 fpm is the "no flow" condition.



Airflow (cfm) vs. Static Pressure Drop (In. WG) for 5' - 0" (L) Silencer

Silencer Dia (in)	Face Area (ft ²)	Static Pressure Drop (In. WG)										
		0.10	0.15	0.20	0.25	0.30	0.40	0.50	0.60	0.70	0.80	1.00
12	0.79	700	850	980	1,100	1,200	1,390	1,550	1,700	1,840	1,970	2,200
14	1.07	1,200	1,470	1,700	1,900	2,080	2,420	2,700	2,950	3,200	3,400	3,800
16	1.40	1,740	2,130	2,470	2,850	3,020	3,480	3,900	4,260	4,600	4,940	5,700
18	1.77	2,570	3,150	3,640	4,060	4,450	5,150	5,750	6,300	6,800	7,250	8,100
20	2.18	3,480	4,250	4,900	5,500	6,020	6,950	7,800	8,500	9,200	9,800	11,000
22	2.64	4,630	5,650	6,500	7,300	8,000	9,260	10,300	11,300	12,200	13,000	14,600
24	3.14	5,920	7,240	8,400	9,350	10,400	11,800	13,200	14,500	15,600	16,800	18,700
26	3.69	7,500	9,150	10,600	11,850	13,000	15,000	16,800	18,300	19,800	21,200	23,700
28	4.28	9,200	11,250	13,000	14,500	15,900	18,400	20,600	22,500	24,300	26,000	29,000
30	4.91	11,075	13,500	15,650	17,500	19,300	22,100	24,800	27,150	29,250	31,300	35,000
32	5.59	13,200	16,300	18,600	20,900	22,800	26,400	29,600	32,200	34,900	37,300	41,700
34	6.31	15,500	19,000	22,000	24,600	27,000	31,000	34,800	38,000	41,000	44,000	49,200
36	7.07	18,000	22,000	25,400	28,400	31,200	36,000	40,200	44,000	47,500	51,000	57,000
38	7.88	20,800	25,400	29,500	33,000	36,200	41,600	46,500	50,800	55,000	59,000	66,000
40	8.73	23,700	29,000	33,500	37,500	41,000	47,400	53,000	58,000	62,600	67,000	75,000
42	9.62	27,000	33,100	38,200	42,650	46,750	54,000	60,400	66,000	71,500	76,500	85,500
44	10.56	30,200	37,000	42,600	47,700	52,250	60,400	67,500	74,000	79,700	85,200	95,400
46	11.54	33,800	41,400	47,700	53,300	58,400	67,600	75,500	82,800	89,000	95,400	106,600
48	12.57	37,200	45,600	52,600	59,000	64,500	74,500	83,500	91,000	98,500	106,000	118,000

Correction Factors for Silencer Lengths Other Than 5'-0" (L)						
Silencer Diameter	Length					
	2'-0"	3'-0"	4'-0"	6'-0"	7'-0"	8'-0"
12"-14"	0.64	0.72	0.86	N/A	N/A	N/A
16"-24"	N/A	0.89	0.94	N/A	N/A	N/A
26"-30"	N/A	N/A	0.95	1.08	N/A	N/A
32"-36"	N/A	N/A	N/A	1.12	1.21	N/A
38"-42"	N/A	N/A	N/A	1.14	1.23	1.30
44"-50"	N/A	N/A	N/A	N/A	1.24	1.34

N/A = Silencer not available in the indicated length

Notes:

1. Net insertion loss, self-generated noise and pressure drop data were obtained through tests conducted by an independent testing laboratory in accordance with ASTM Standard E477-96, entitled "Standard Method of Testing Duct Liner Materials and Prefabricated Silencers for Acoustical and Airflow Performance." Test specimens whose inside diameters correspond to 6", 12", 18", 24", 30", 36", and 42" and whose lengths correspond to the minimum and maximum lengths catalogued were tested and reported. All data presented for other diameters and lengths were interpolated or extrapolated.
2. The pressure drop performance data obtained from ASTM E477-96 "Standard Method of Testing Duct Liner Materials and Prefabricated Silencers for Acoustical and Airflow Performance" are tested at simulated ideal ducted inlet and ducted outlet conditions. Any deviations from these ideal conditions on actual silencer installations should be accounted for in the form of additional pressure loss.
3. The self-generated noise for elbow silencers and straight silencers without a baffle is too low to be measured by ASTM E477-96. The measurements obtained for these silencers are equal to or less than the corresponding single wall duct reference condition or within +/- 10dB per ASTM E477-96 section 9.1.2.

Elbow silencers

BSLGU



Description

The BSLGU elbow silencer is developed for use in duct systems where space considerations or other circumstances prevent the use of straight silencers, e.g. SLGU.

The elbow silencer is made of 2 gored elbows. The inner elbow is made of perforated steel sheet. The space between is filled with inorganic glass fiber absorption material. There is a fiber retention system between the perforated inner shell and the glass fiber material in order to prevent the erosion of fiberglass into the airstream.

BSLGU silencers are supplied with Lindab Safe® end treatment as standard.

The BSLGU elbow silencers are available in 2" insulation thickness from 4" through 12" diameter and 4" thickness from 4" insulation through 24" diameter.

Dimension

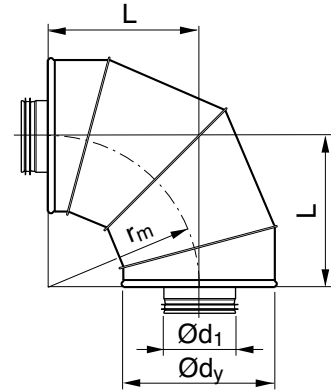

$$r_m = 1.0 \times \text{Ø}d_y$$

$$L = \text{Ø}d_1 + (2 \times i)$$

$$\text{Ø}d_y = \text{Ø}d_1 + (2 \times i)$$

i = insulation thickness (inch)

Ordering example

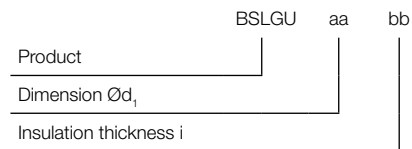

Elbow silencers

BSLGU

Acoustical Performance – Net Insertion Loss

Octave band	1	2	3	4	5	6	7	8	1	2	3	4	5	6	7	8	
Frequency (Hz)	63	125	250	500	1K	2K	4K	8K	63	125	250	500	1K	2K	4K	8K	
Ød ₁ (in)	Velocity (fpm)	Net Insertion Loss (Decibels)								Net Insertion Loss (Decibels)							
L (in)		BSLGU 02								BSLGU 04							
3	-6000	8	7	16	27	31	37	32	24	11	17	27	35	34	44	38	27
	-4000	6	7	16	26	30	38	32	24	10	16	27	35	34	44	38	28
	-2000	7	5	15	26	29	36	32	25	11	15	26	34	34	43	38	28
	0	6	6	14	25	28	36	31	25	10	14	26	33	33	43	38	28
	+2000	6	6	13	24	27	35	30	25	11	12	25	32	34	42	36	29
	+4000	8	5	13	23	26	34	29	24	11	13	24	31	33	41	36	30
	+6000	8	5	12	22	25	33	28	24	11	12	22	30	32	40	36	32
4	-6000	7	6	15	27	31	36	31	23	10	16	27	34	35	43	36	26
	-4000	6	6	15	26	30	36	31	23	10	15	27	34	35	43	36	27
	-2000	6	5	14	25	29	35	31	24	10	14	26	33	35	42	36	27
	0	5	5	13	24	28	35	30	24	9	13	25	32	34	42	36	27
	+2000	6	5	12	23	27	34	29	24	10	12	24	31	34	41	35	28
	+4000	7	4	12	22	26	33	28	23	10	12	23	30	33	40	35	29
	+6000	7	4	11	21	25	32	27	23	10	11	21	29	32	39	35	30
5	-6000	6	6	15	27	32	35	30	22	10	16	27	34	36	42	35	26
	-4000	6	6	15	26	31	35	30	22	10	15	27	34	36	42	35	27
	-2000	6	5	14	25	30	34	30	23	10	14	26	33	36	41	35	27
	0	5	5	13	24	29	34	29	23	8	13	25	32	35	41	34	26
	+2000	6	5	12	23	28	33	28	23	10	12	24	31	35	40	34	27
	+4000	7	4	11	21	26	32	27	22	10	12	22	30	33	39	34	28
	+6000	7	4	11	20	25	31	26	22	10	11	21	29	32	38	34	29
6	-6000	5	5	14	27	32	34	29	21	9	15	27	33	37	41	33	25
	-4000	6	5	14	26	31	33	29	21	10	14	27	33	37	41	33	26
	-2000	5	5	13	24	30	33	29	22	9	13	26	32	37	40	33	26
	0	4	4	12	23	29	33	28	22	7	12	24	31	36	40	32	25
	+2000	6	4	11	22	28	32	27	22	9	12	23	30	35	39	33	26
	+4000	6	3	10	20	26	31	26	21	9	11	21	29	33	38	33	27
	+6000	6	3	10	19	25	30	25	21	9	10	20	28	32	37	33	27
7	-4000	5	5	14	26	33	33	28	20	9	15	27	33	38	41	32	24
	-3000	6	5	13	25	32	32	28	20	9	14	27	33	38	41	32	25
	-2000	5	5	12	24	31	32	28	21	9	13	26	32	38	40	32	25
	0	4	4	12	23	30	32	27	21	7	12	24	31	37	39	31	24
	+2000	6	4	11	22	29	31	26	21	9	12	23	30	36	39	32	25
	+3000	6	3	10	20	27	30	25	20	9	11	21	28	35	38	32	26
	+4000	6	3	10	19	26	29	24	20	9	10	20	28	34	37	32	26
8	-5000	5	5	13	24	33	31	26	19	8	14	26	32	39	40	31	23
	-4000	5	4	12	24	33	30	26	19	8	13	26	32	39	40	31	23
	-2000	5	4	11	23	32	30	26	20	8	12	25	31	38	39	31	24
	0	4	4	11	23	31	30	26	20	7	11	24	30	37	38	30	23
	+2000	5	4	10	22	30	30	25	20	8	11	23	29	37	38	30	23
	+4000	5	3	10	20	27	29	24	19	8	10	20	27	36	37	30	24
	+5000	5	3	10	19	27	28	23	19	8	10	20	27	35	36	30	24
L (in)		BSLGU 02								BSLGU 04							
9	-4000	5	5	13	24	29	29	24	18	8	14	26	32	40	39	30	22
	-3000	5	4	12	24	33	29	25	19	8	13	26	32	40	39	30	22

We reserve the right to make changes without prior notice. Therefore, all designs, specifications, and product features are subject to change without notice. The company and its products are protected by patents and registered trademarks. Linx Industries, Inc. Copyright 2015 All rights reserved.



Elbow silencers

BSL GU

Acoustical Performance – Net Insertion Loss

Octave band	1	2	3	4	5	6	7	8	1	2	3	4	5	6	7	8		
Frequency (Hz)	63	125	250	500	1K	2K	4K	8K	63	125	250	500	1K	2K	4K	8K		
Ød ₁ (in)	Velocity (fpm)	Net Insertion Loss (Decibels)							Net Insertion Loss (Decibels)									
	-2000	5	4	11	23	33	29	25	19	8	12	25	31	39	38	30	23	
	0	4	4	11	23	32	29	25	19	7	11	24	30	38	37	29	22	
	+2000	5	4	10	22	31	29	24	19	8	11	23	29	38	37	29	22	
	+3000	5	3	10	20	29	28	23	18	8	10	21	27	37	37	29	23	
	+4000	5	3	10	20	28	27	22	18	8	10	20	27	36	36	29	23	
10	-4000	4	5	12	24	24	27	22	17	7	13	26	31	41	38	28	21	
	-3000	4	4	11	24	33	27	23	18	7	13	25	31	41	38	28	21	
	-2000	4	4	10	23	33	27	23	18	7	12	24	30	40	37	28	21	
	0	3	4	10	22	32	27	23	18	6	11	23	29	39	36	28	21	
	+2000	4	4	10	21	31	27	23	18	7	11	22	28	38	36	28	21	
	+3000	4	3	9	20	30	27	22	17	7	10	21	27	38	36	28	21	
	+4000	4	3	9	20	29	26	21	17	7	10	20	27	37	35	28	21	
12	-4000	3	5	11	24	34	25	19	15	6	12	25	30	42	36	25	19	
	-3000	2	4	10	23	34	25	19	16	7	11	25	30	42	36	26	20	
	-2000	3	4	10	23	34	25	20	16	7	11	24	30	42	35	26	19	
	0	2	4	9	22	33	24	20	16	5	10	23	28	41	35	26	19	
	+2000	2	4	9	22	33	24	20	16	6	10	22	27	40	34	26	19	
	+3000	2	3	8	20	31	24	19	14	6	10	21	26	40	34	26	18	
	+4000	2	3	8	20	31	24	19	14	5	9	21	26	40	34	26	18	
14	-4000								5	11	25	30	39	24	25	19		
	-3000								5	11	25	30	39	34	25	19		
	-2000								5	11	24	29	38	34	25	19		
	0								4	10	24	29	38	33	24	19		
	+2000								4	10	23	29	36	30	23	18		
	+3000								4	9	22	28	36	30	23	18		
	+4000								4	9	21	27	35	30	22	19		
16	-4000								4	10	25	31	36	32	23	19		
	-3000								4	10	25	30	36	32	23	18		
	-2000								4	10	24	30	36	31	23	18		
	0								3	9	24	30	36	31	23	18		
	+2000								3	9	23	29	36	30	23	18		
	+3000								3	9	22	28	36	30	23	18		
	+4000								3	9	21	27	35	30	22	18		
18	-4000								4	10	25	31	33	30	22	18		
	-3000								3	10	24	31	34	30	22	18		
	-2000								3	10	24	30	34	30	22	18		
	0								2	9	24	30	34	29	22	18		
	+2000								3	9	22	28	34	29	22	18		
	+3000								3	8	21	27	33	29	22	17		
	+4000								2	8	21	28	33	28	21	17		
L (in)		BSL GU 02							BSL GU 04									
20	-3000								3	9	25	33	33	30	23	18		
	-2000								3	9	24	33	33	30	23	18		
	-1000								3	8	24	33	33	30	23	18		
	0								2	8	24	32	33	29	23	18		
	+1000								2	8	23	32	33	29	23	18		
	+2000								2	8	22	31	33	29	23	18		

We reserve the right to make changes without prior notice. Therefore, all designs, specifications, and product features are subject to change without notice. The company and its products are protected by patents and registered trademarks. Linx Industries, Inc. Copyright 2015 All rights reserved.



Acoustical Performance – Net Insertion Loss

Octave band	1	2	3	4	5	6	7	8	1	2	3	4	5	6	7	8
Frequency (Hz)	63	125	250	500	1K	2K	4K	8K	63	125	250	500	1K	2K	4K	8K
Ød ₁ (in)	Velocity (fpm)	Net Insertion Loss (Decibels)							Net Insertion Loss (Decibels)							
	+3000								2	8	21	30	33	29	22	18
22	-3000								3	9	24	36	32	30	23	19
	-2000								3	8	24	36	32	30	23	18
	-1000								2	8	23	35	32	30	23	18
	0								2	8	23	35	32	29	23	18
	+1000								2	8	22	34	33	29	23	18
	+2000								1	7	22	34	33	29	23	18
	+3000								2	7	21	33	33	29	23	18
24	-3000								3	8	23	39	31	29	23	19
	-2000								3	8	23	39	31	29	23	19
	-1000								3	8	23	39	31	29	23	18
	0								2	7	22	38	31	29	23	18
	+1000								2	7	21	37	32	29	23	18
	+2000								3	7	21	37	32	29	23	18
	+3000								2	7	21	36	33	29	23	18

Notes:

- Net insertion loss, self-generated noise and pressure drop data were obtained through tests conducted by an independent testing laboratory in accordance with ASTM Standard E477-96, entitled "Standard Method of Testing Duct Liner Materials and Prefabricated Silencers for Acoustical and Airflow Performance." Test specimens whose inside diameters correspond to 6", 12", 18", 24", 30", 36", and 42" and whose lengths correspond to the minimum and maximum lengths catalogued were tested and reported. All data presented for other diameters and lengths were interpolated or extrapolated.
- Velocity, indicated as fpm, is determined by dividing the air flow through the silencer (ft³/min) by the cross sectional area of the silencer face (ft²) calculated using the silencer clear inside diameter. Return/exhaust air is indicated as (-) fpm and supply air is indicated as (+) fpm. 0 fpm is the "no flow" condition.
- The pressure drop performance data obtained from ASTM E477-96 "Standard Method of Testing Duct Liner Materials and Prefabricated Silencers for Acoustical and Airflow Performance" are tested at simulated ideal ducted inlet and ducted outlet conditions. Any deviations from these ideal conditions on actual silencer installations should be accounted for in the form of additional pressure loss.
- The self-generated noise for elbow silencers and straight silencers without a baffle is too low to be measured by ASTM E477-96. The measurements obtained for these silencers are equal to or less than the corresponding single wall duct reference condition or within +/- 10dB per ASTM E477-96 section 9.1.2.

Rectangular silencers

SLRS



Description

The SLRA silencer is manufactured with a frame of galvanized sheet and Lindtec™ backed sound absorption material. The Lindtec™ surface is easy to clean and prevents removal of fibers, while allowing increase exposure of sound attenuation media.

Due to the aerodynamic design, the SLRS has a low pressure loss and a low generation of flow noise. The baffle is available in a width of 8 in. The SLRS is also available in other lengths and with other baffle spacing configurations to suit every need.

Dimensions

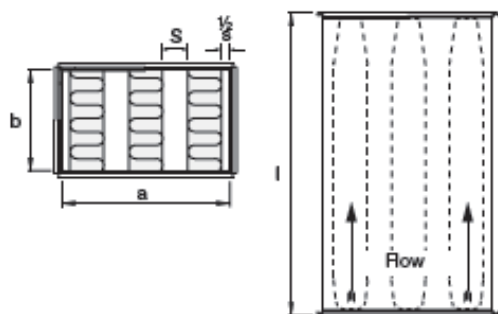

Ordering example

	SLRS	8	4	48	36	40	LS
Product	_____						
Baffle width (in)	_____						
Baffle distance (in)	_____						
a (in)	_____						
b (in)	_____						
l (in)	_____						
Connection type, e.g. LS	_____						

We reserve the right to make changes without prior notice. Therefore, all designs, specifications, and product features are subject to change without notice. The company and its products are protected by patents and registered trademarks. Linx Industries, Inc. Copyright 2015 All rights reserved.

Dimension

Baffle Spacing S = 2.5 in

Length (inch)	Attenuation [dB] for center frequency [Hz]								Pressure value ξ
	63	125	250	500	1k	2k	4k	8k	
40	5	11	23	34	48	43	28	20	10.2
60	7	16	34	50	50	50	39	27	12.9
80	9	22	45	50	50	50	49	33	15.6
100	11	27	50	50	50	50	50	38	18.2

Baffle Spacing S = 3 in

Length (inch)	Attenuation [dB] for center frequency [Hz]								Pressure value ξ
	63	125	250	500	1k	2k	4k	8k	
40	4	9	20	30	42	36	23	17	5.5
60	5	14	29	44	50	50	32	22	6.9
80	7	18	39	50	50	50	40	27	8.2
100	8	22	48	50	50	50	48	31	9.5

Baffle Spacing S = 4 in

Length (inch)	Attenuation [dB] for center frequency [Hz]								Pressure value ξ
	63	125	250	500	1k	2k	4k	8k	
40	3	8	18	27	37	29	19	14	3.2
60	5	12	26	40	50	44	27	18	4.0
80	6	16	34	50	50	50	33	22	4.8
100	11	27	50	50	50	50	50	38	18.2

Baffle Spacing S = 5 in

Length (inch)	Attenuation [dB] for center frequency [Hz]								Pressure value ξ
	63	125	250	500	1k	2k	4k	8k	
40	3	7	16	25	32	24	16	11	2.0
60	4	11	23	36	50	36	22	15	2.5
80	5	14	31	48	50	47	28	18	3.0
100	6	17	38	50	50	50	33	21	3.5

Baffle Spacing S = 5.5 in

Length (inch)	Attenuation [dB] for center frequency [Hz]								Pressure value ξ
	63	125	250	500	1k	2k	4k	8k	
40	3	7	15	23	28	20	13	9	1.3
60	4	10	22	34	44	30	18	12	1.7
80	4	13	28	45	50	39	23	15	2.0
100	5	16	35	50	50	48	27	18	2.4

NB. Maximum attenuation specified is 50 dB. The pressure loss Δp in Pa can be calculated from the pressure value ξ : $\Delta p = 0.6 \times v^2 \times \xi$ where (v) is the velocity on the face area of the silencer.

The lengths shown above are only examples, other lengths between are also available. Minimum length is 20 in. Maximum length is 98 in. For lengths over 98 in, the silencer will be divided into two or more silencers.



Silencer baffle

SLRA

35

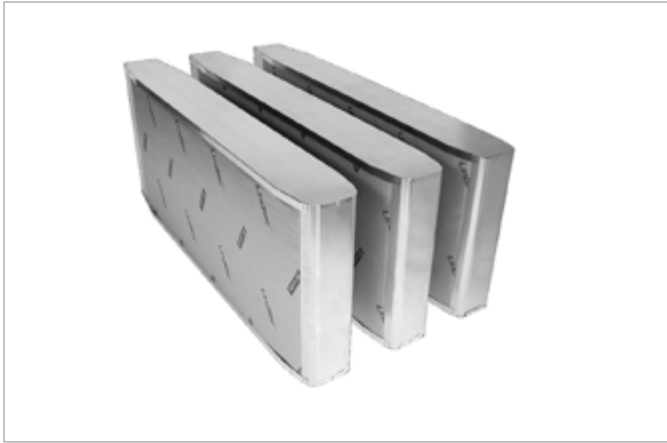

Description

The SLRA baffle is manufactured with a frame of galvanized sheet and Lindtec™ backed sound absorption material. The Lindtec™ surface is easy to clean and prevents removal of fibers, while allowing increased exposure of sound attenuation media.

Due to the aerodynamic design, the SLRA has a low pressure loss and a low generation of flow noise. The SLRA is available in a width of 8 in. The SLRA is also available in other lengths and with other baffle spacing configurations to suit every need.

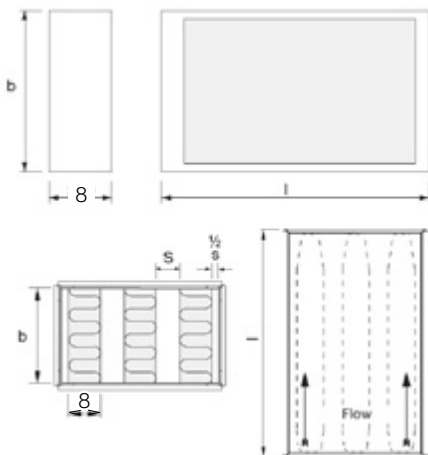

Ordering example

	SLRA	8	24	40
Baffle width (in)				
b (in)				
l nom.(in)				

Dimension

Baffle Spacing S = 2.5 in

Length (inch)	Attenuation [dB] for center frequency [Hz]								Pressure value ξ
	63	125	250	500	1k	2k	4k	8k	
40	5	11	23	34	48	43	28	20	10.2
60	7	16	34	50	50	50	39	27	12.9
80	9	22	45	50	50	50	49	33	15.6
100	11	27	50	50	50	50	50	38	18.2

Baffle Spacing S = 3 in

Length (inch)	Attenuation [dB] for center frequency [Hz]								Pressure value ξ
	63	125	250	500	1k	2k	4k	8k	
40	4	9	20	30	42	36	23	17	5.5
60	5	14	29	44	50	50	32	22	6.9
80	7	18	39	50	50	50	40	27	8.2
100	8	22	48	50	50	50	48	31	9.5

Baffle Spacing S = 4 in

Length (inch)	Attenuation [dB] for center frequency [Hz]								Pressure value ξ
	63	125	250	500	1k	2k	4k	8k	
40	3	8	18	27	37	29	19	14	3.2
60	5	12	26	40	50	44	27	18	4.0
80	6	16	34	50	50	50	33	22	4.8
100	11	27	50	50	50	50	50	38	18.2

Baffle Spacing S = 5 in

Length (inch)	Attenuation [dB] for center frequency [Hz]								Pressure value ξ
	63	125	250	500	1k	2k	4k	8k	
40	3	7	16	25	32	24	16	11	2.0
60	4	11	23	36	50	36	22	15	2.5
80	5	14	31	48	50	47	28	18	3.0
100	6	17	38	50	50	50	33	21	3.5

Baffle Spacing S = 5.5 in

Length (inch)	Attenuation [dB] for center frequency [Hz]								Pressure value ξ
	63	125	250	500	1k	2k	4k	8k	
40	3	7	15	23	28	20	13	9	1.3
60	4	10	22	34	44	30	18	12	1.7
80	4	13	28	45	50	39	23	15	2.0
100	5	16	35	50	50	48	27	18	2.4

NB. Maximum attenuation specified is 50 dB. The pressure loss Δp in Pa can be calculated from the pressure value ξ : $\Delta p = 0.6 \times v^2 \times \xi$ where (v) is the velocity on the face area of the silencer.

The lengths shown above are only examples, other lengths between are also available. Minimum length is 20 in.

Note: l, nom means that the length in the Order Examples normally are meant as the length of the duct, the baffle will be a bit shorter to prevent mounting problems.





Linx Industries, Inc.
2600 Airline Boulevard
Portsmouth, Virginia 23701
Phone: 800.797.7476
Fax: 757.488.4502
www.li-hvac.com



REV01.2015

We reserve the right to make changes without prior notice. Therefore, all designs, specifications, and product features are subject to change without notice. The company and its products are protected by patents and registered trademarks. Linx Industries, Inc. Copyright 2015 All rights reserved.