

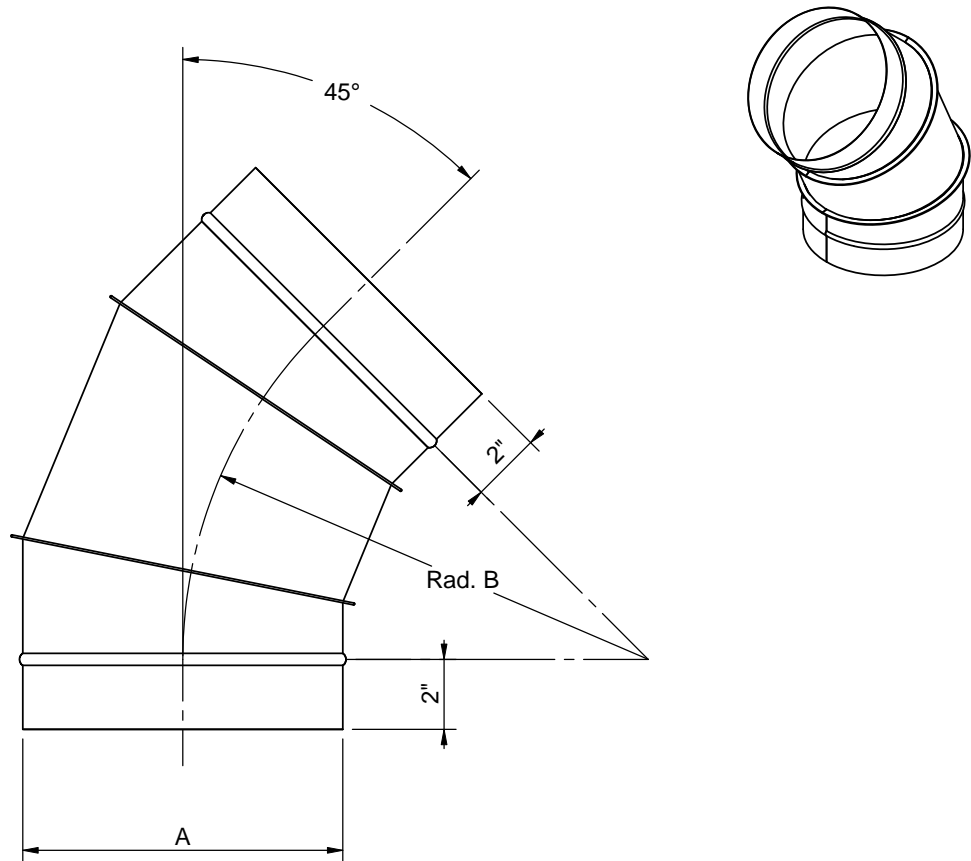

STANDING SEAM ELBOWS 45 1.5 CL



1.5 CENTERLINE = RADIUS = DIAMETER x 1.5

MATERIAL: GALVANIZED - SEE DESCRIPTION FOR GAUGE

SPECIFICATIONS

Pg. 1 of 2

STOCK #	DESCRIPTION	DIMENSIONS (in)					
		A	B	C	D	E	F
547955	5X45 STANDING SEAM 26GA 1.5CL	5	7 1/2				
547956	6X45 STANDING SEAM 26GA 1.5CL	6	9				
547957	7X45 STANDING SEAM 26GA 1.5CL	7	10 1/2				
547958	8X45 STANDING SEAM 26GA 1.5CL	8	12				
547959	9X45 STANDING SEAM 26GA 1.5CL	9	13 1/2				
547960	10X45 STANDING SEAM 26GA 1.5CL	10	15				
547962	12X45 STANDING SEAM 26GA 1.5CL	12	18				
547964	14X45 STANDING SEAM 26GA 1.5CL	13-15/16	21				
547966	16X45 STANDING SEAM 26GA 1.5CL	15-15/16	24				
547968	18X45 STANDING SEAM 26GA 1.5CL	17-7/8	27				

ECCO Manufacturing
a division of **ECCO HEATING PRODUCTS LTD.**

www.eccomfg.com

Date: December 7, 2007

Project:

Engineer:

Contractor:

